

### 5M

**PITCH 5 mm**  
FOR BELT WIDTH 15 mm

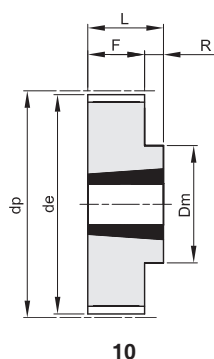

10

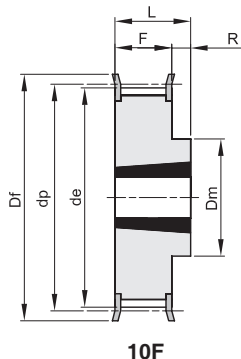

10F

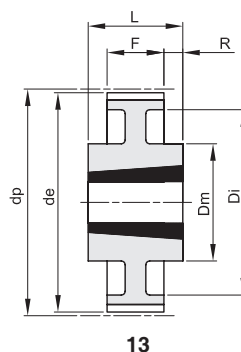

13

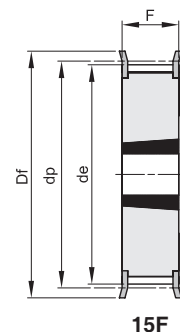

15F

Материал Стомана (St) / Material Steel (St)

code	type	material	teeth	taper bush	bore max	dp	de	Df	Dm	Di	F	L	R	n° flange	Kg.
TL 34 5M 15	15F	St	34	1008	25	54,11	52,97	57			22	22		213	0,20
TL 36 5M 15	15F	St	36	1108	25	57,30	56,15	60			22	22		214	0,25
TL 38 5M 15	15F	St	38	1108	25	60,48	59,34	66			22	22		216	0,30
TL 40 5M 15	15F	St	40	1108	25	63,66	62,52	71			22	22		217	0,35
TL 44 5M 15	15F	St	44	1108	25	70,03	68,89	75			22	22		218	0,40
TL 48 5M 15	10F	St	48	1210	32	76,39	75,25	83	59		22	25	3	219	0,46
TL 56 5M 15	10F	St	56	1210	32	89,13	87,99	93	70		22	25	3	222	0,60
TL 64 5M 15	10F	St	64	1210	32	101,86	100,72	106	80		22	25	3	224	0,80
TL 72 5M 15	10	St	72	1610	42	114,59	113,45		92		22	25	3		1,20
TL 80 5M 15	10	St	80	1610	42	127,32	126,18		92		22	25	3		1,76
TL 90 5M 15	10	St	90	1610	42	143,24	142,10		92		22	25	3		2,32
TL112 5M 15	10	St	112	2012	50	178,25	177,11		110		20	32	12		3,72
TL136 5M 15	13	St	136	2012	50	216,45	215,31		110	199	20	32	6		3,82

### 8M

PITCH 8 mm  
FOR BELT WIDTH 20 mm

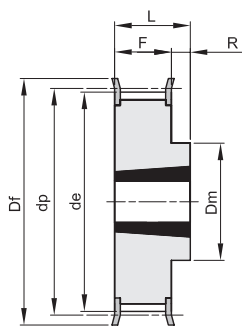

10F

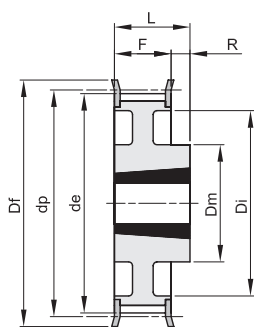

11F

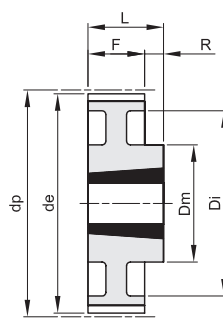

11

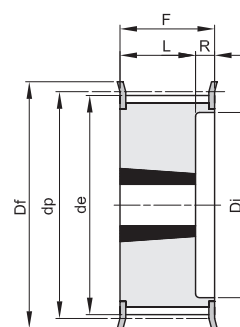

16F

Материал Стомана (St) / Material Steel (St)

Материал Чугун (GG) / Material Cast Iron (GG)

code	type	material	teeth	taper bush	bore max	dp	de	Df	Dm	Di	F	L	R	n° flange	Kg.
TL 22 8M 20	16F	St	22	1008	25	56,02	54,65	60		37	28	22	6	308	0,25
TL 24 8M 20	16F	St	24	1108	25	61,11	59,74	66		44	28	22	6	310	0,30
TL 26 8M 20	16F	St	26	1108	25	66,21	64,84	71		45	28	22	6	311	0,36
TL 28 8M 20	16F	St	28	1108	25	71,30	70,08	75		50	28	22	6	312	0,45
TL 30 8M 20	16F	St	30	1108	25	76,39	75,13	83		58	28	22	6	314	0,55
TL 32 8M 20	16F	St	32	1610	42	81,49	80,16	87		63	28	25	3	315	0,43
TL 34 8M 20	16F	St	34	1610	42	86,58	85,21	91		64	28	25	3	316	0,57
TL 36 8M 20	16F	St	36	1610	42	91,67	90,30	98		68	28	25	3	319	0,70
TL 38 8M 20	16F	St	38	1610	42	96,77	95,39	103		72	28	25	3	320	0,82
TL 40 8M 20	16F	St	40	1610	42	101,86	100,49	106		76	28	25	3	321	1,10
TL 44 8M 20	10F	St	44	2012	50	112,05	110,67	119	92		28	32	4	325	1,20
TL 48 8M 20	10F	St	48	2012	50	122,23	120,86	127	96		28	32	4	327	1,65
TL 56 8M 20	10F	St	56	2012	50	142,60	141,23	148	110		28	32	4	333	2,50
TL 64 8M 20	11F	St	64	2012	50	162,97	161,60	168	110	137	28	32	4	338	2,60
TL 72 8M 20	11F	St	72	2012	50	183,35	181,97	192	110	158	28	32	4	340	3,40
TL 80 8M 20	11	GG	80	2012	50	203,72	202,35		110	180	28	32	4		3,60
TL 90 8M 20	11	GG	90	2012	50	229,18	227,81		110	204	28	32	4		4,10

### 8M

PITCH 8 mm  
FOR BELT WIDTH 30 mm

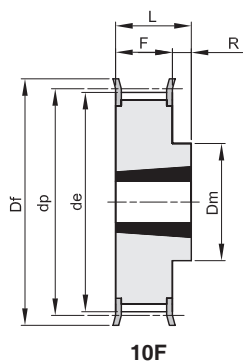

10F

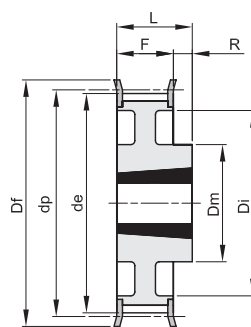

11F

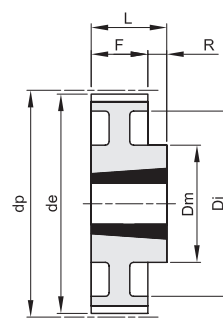

11

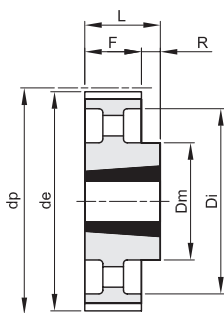

12

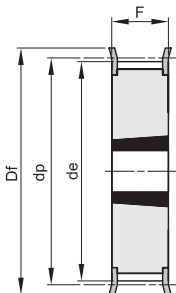

15F

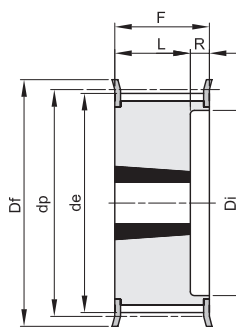

16F

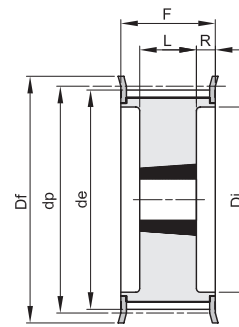

18F

Материал Стомана (St) / Material Steel (St)

Материал Чугун (GG) / Material Cast Iron (GG)

code	type	material	teeth	taper bush	bore max	dp	de	Df	Dm	Di	F	L	R	n° flange	Kg.
TL 22 8M 30	16F	St	22	1008	25	56,02	54,65	60		37	38	22	16	308	0,33
TL 24 8M 30	16F	St	24	1108	25	61,11	59,74	66		44	38	22	16	310	0,40
TL 26 8M 30	16F	St	26	1108	25	66,21	64,84	71		44	38	22	16	311	0,45
TL 28 8M 30	16F	St	28	1210	32	71,30	70,08	75		50	38	25	13	312	0,50
TL 30 8M 30	15F	St	30	1615	42	76,39	75,13	83			38	38		314	0,55
TL 32 8M 30	15F	St	32	1615	42	81,49	80,16	87			38	38		315	0,60
TL 34 8M 30	15F	St	34	1615	42	86,58	85,21	91			38	38		316	0,80
TL 36 8M 30	15F	St	36	1615	42	91,67	90,30	98			38	38		319	1,00
TL 38 8M 30	15F	St	38	1615	42	96,77	95,39	103			38	38		320	1,10
TL 40 8M 30	15F	St	40	1615	42	101,86	100,49	106			38	38		321	1,34
TL 44 8M 30	18F	St	44	2012	50	112,05	110,67	119		86	38	32	3	325	1,30
TL 48 8M 30	18F	St	48	2012	50	122,23	120,86	127		90	38	32	3	327	1,80
TL 56 8M 30	18F	St	56	2012	50	142,60	141,23	148		110	38	32	3	333	3,80
TL 64 8M 30	10F	St	64	2517	60	162,97	161,60	168	125		38	45	7	338	4,30
TL 72 8M 30	11F	St	72	2517	60	183,35	181,97	192	125	158	38	45	7	340	4,40
TL 80 8M 30	11	GG	80	2517	60	203,72	202,35		125	180	38	45	7		4,65
TL 90 8M 30	11	GG	90	2517	60	229,18	227,81		125	204	38	45	7		5,80
TL112 8M 30	12	GG	112	2517	60	285,21	283,83		125	254	38	45	7		6,20
TL144 8M 30	12	GG	144	2517	60	366,69	365,32		125	336	38	45	7		9,00

### 8M

**PITCH 8 mm**  
FOR BELT WIDTH 50 mm

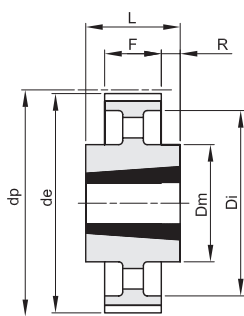

14

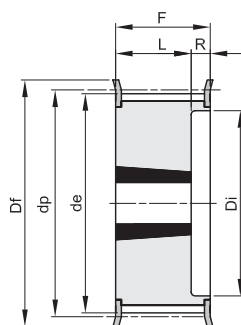

16F

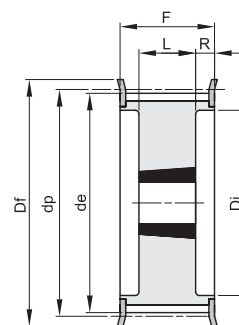

18F

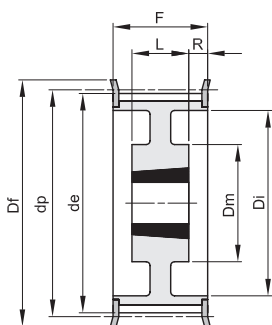

19F

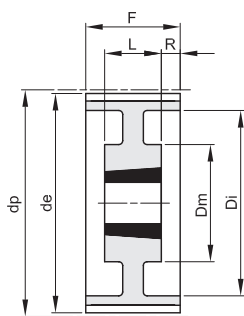

19

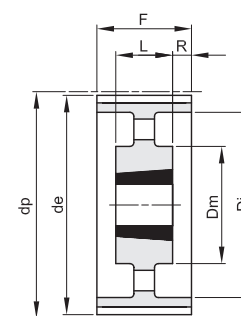

20

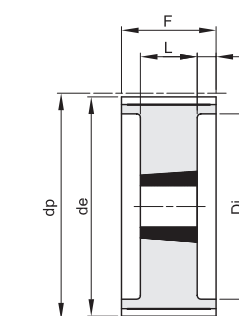

18

Материал Стомана (St) / Material Steel (St)

Материал Чугун (GG) / Material Cast Iron (GG)

code	type	material	teeth	taper bush	bore max	dp	de	Df	Dm	Di	F	L	R	n° flange	Kg.
TL 28 8M 50	16F	St	28	1210	32	71,30	70,08	75		50	60	25	35	312	0,60
TL 30 8M 50	16F	St	30	1615	42	76,39	75,13	83		58	60	38	22	314	0,65
TL 32 8M 50	16F	St	32	1615	42	81,49	80,16	87		63	60	38	22	315	0,80
TL 34 8M 50	16F	St	34	1615	42	86,58	85,21	91		65	60	38	22	316	1,08
TL 36 8M 50	16F	St	36	1615	42	91,67	90,30	98		68	60	38	22	319	1,35
TL 38 8M 50	16F	St	38	1615	42	96,77	95,39	103		72	60	38	22	320	1,65
TL 40 8M 50	18F	St	40	2012	50	101,86	100,49	106		80	60	32	14	321	1,70
TL 44 8M 50	18F	St	44	2012	50	112,05	110,67	119		86	60	32	14	325	1,80
TL 48 8M 50	18F	St	48	2012	50	122,23	120,86	127		95	60	32	14	327	2,35
TL 56 8M 50	18F	St	56	2517	60	142,60	141,23	148		116	60	45	7,5	333	3,35
TL 64 8M 50	18F	St	64	2517	60	162,97	161,60	168		136	60	45	7,5	338	4,90
TL 72 8M 50	19F	St	72	2517	60	183,35	181,97	192	125	158	60	45	7,5	340	6,90
TL 80 8M 50	18	GG	80	3020	75	203,72	202,35			180	60	51	4,5		8,90
TL 90 8M 50	19	GG	90	3020	75	229,18	227,81		160	204	60	51	4,5		9,90
TL112 8M 50	19	GG	112	3020	75	285,21	283,83		170	254	60	51	4,5		12,10
TL144 8M 50	20	GG	144	3020	75	366,69	365,32		170	336	60	51	4,5		15,40
TL168 8M 50	14	GG	168	3525	90	427,81	426,44		198	395	60	65	2,5		22,80
TL192 8M 50	14	GG	192	3525	90	488,92	487,55		198	455	60	65	2,5		26,50

### 8M

**PITCH 8 mm**  
FOR BELT WIDTH 85 mm

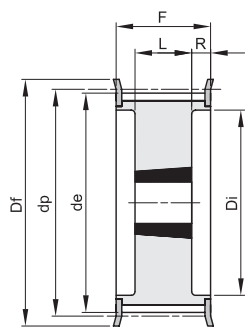

18F

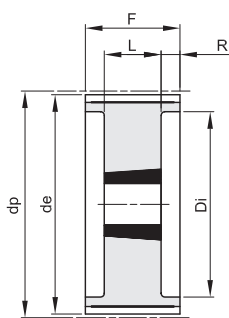

18

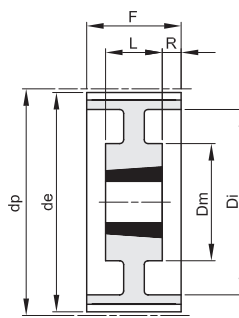

19

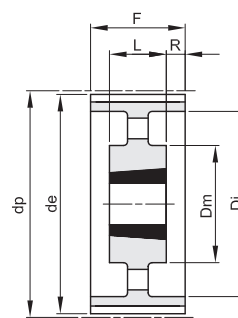

20

Материал Стомана (St) / Material Steel (St)

Материал Чугун (GG) / Material Cast Iron (GG)

code	type	material	teeth	taper bush	bore max	dp	de	Df	Dm	Di	F	L	R	n° flange	Kg.
TL 34 8M 85	18F	St	34	1615	42	86,58	85,22	91		65	95	38	28,5	316	1,50
TL 36 8M 85	18F	St	36	1615	42	91,67	90,30	98		68	95	38	28,5	319	1,90
TL 38 8M 85	18F	St	38	1615	42	96,77	95,39	103		72	95	38	28,5	320	2,20
TL 40 8M 85	18F	St	40	2012	50	101,86	100,49	106		80	95	32	31,5	321	1,90
TL 44 8M 85	18F	St	44	2012	50	112,05	110,67	119		86	95	32	31,5	325	2,30
TL 48 8M 85	18F	St	48	2517	60	122,23	120,86	127		97	95	45	25	327	2,70
TL 56 8M 85	18F	St	56	2517	60	142,60	141,23	148		116	95	45	25	333	4,50
TL 64 8M 85	18F	St	64	2517	60	162,97	161,60	168		136	95	45	25	338	6,30
TL 72 8M 85	18F	St	72	3020	75	183,35	181,97	192		150	95	51	22	340	8,10
TL 80 8M 85	18	GG	80	3020	75	203,72	202,35			180	95	51	22		10,20
TL 90 8M 85	19	GG	90	3020	75	229,18	227,81		170	204	95	51	22		11,20
TL112 8M 85	19	GG	112	3020	75	285,21	283,83		170	254	95	51	22		15,00
TL144 8M 85	20	GG	144	3525	90	366,69	365,32		198	336	95	65	15		20,20
TL168 8M 85	20	GG	168	3525	90	427,81	426,44		198	395	95	65	15		22,40
TL192 8M 85	20	GG	192	3525	90	488,92	487,55		198	455	95	65	15		28,20

### 14M

PITCH 14 mm  
FOR BELT WIDTH 40 mm

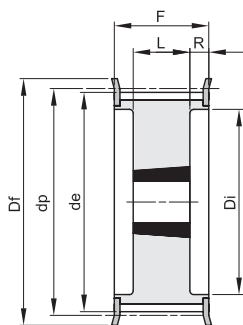

18F

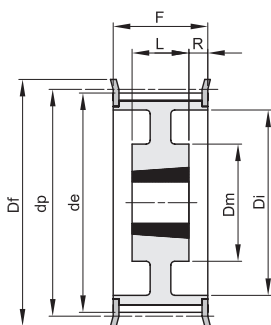

19F

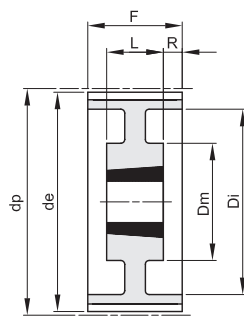

19

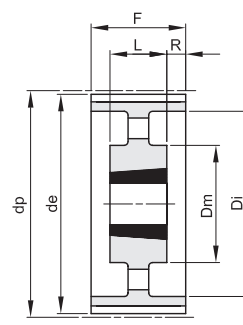

20

Материал Стомана (St) / Material Steel (St)

Материал Чугун (GG) / Material Cast Iron (GG)

code	type	material	teeth	taper bush	bore max	dp	de	Df	Dm	Di	F	L	R	n° flange	Kg.
TL 28 14M 40	18F	St	28	2012	50	124,78	122,12	127		94	54	32	11	400	2,10
TL 30 14M 40	18F	St	30	2012	50	133,69	130,99	138		98	54	32	11	401	2,70
TL 32 14M 40	18F	St	32	2012	50	142,60	139,88	154		108	54	32	11	403	3,40
TL 34 14M 40	18F	St	34	2517	60	151,52	148,79	160		110	54	45	4,5	404	3,90
TL 36 14M 40	18F	St	36	2517	60	160,43	157,68	168		120	54	45	4,5	405	4,80
TL 38 14M 40	18F	St	38	2517	60	169,34	166,60	183		130	54	45	4,5	406	5,40
TL 40 14M 40	18F	St	40	2517	60	178,25	175,49	188		138	54	45	4,5	407	6,00
TL 44 14M 40	18F	St	44	3020	75	196,08	193,28	211		155	54	51	1,5	411	7,50
TL 48 14M 40	18F	St	48	3020	75	213,90	211,11	226		170	54	51	1,5	412	8,50
TL 56 14M 40	18F	GG	56	3020	75	249,55	246,76	256		208	54	51	1,5	416	10,10
TL 64 14M 40	19F	GG	64	3020	75	285,21	282,41	296	170	240	54	51	1,5	418	13,40
TL 72 14M 40	19	GG	72	3020	75	320,86	318,06		170	280	54	51	1,5		15,00
TL 80 14M 40	20	GG	80	3020	75	356,51	353,71		170	315	54	51	1,5		16,00
TL 90 14M 40	20	GG	90	3020	75	401,07	398,28		170	360	54	51	1,5		18,00
TL112 14M 40	20	GG	112	3020	75	499,11	496,32		170	457	54	51	1,5		25,50
TL144 14M 40	20	GG	144	3020	75	641,71	638,92		170	600	54	51	1,5		32,00
TL168 14M 40	20	GG	168	3020	75	748,66	745,87		170	706	54	51	1,5		43,50
TL192 14M 40	20	GG	192	3020	75	855,62	852,82		170	813	54	51	1,5		49,50

### 14M

PITCH 14 mm  
FOR BELT WIDTH 55 mm

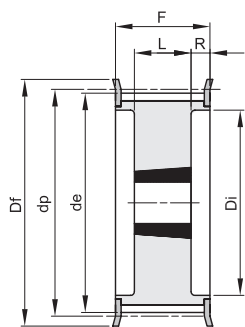

18F

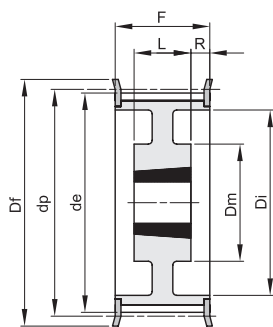

19F

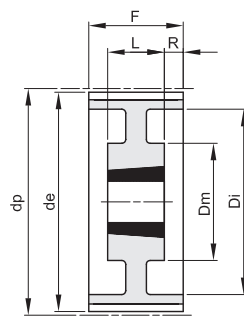

19

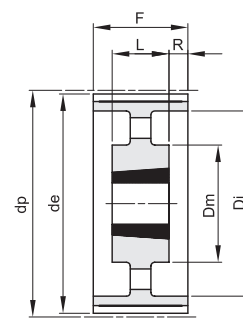

20

Материал Стомана (St) / Material Steel (St)

Материал Чугун (GG) / Material Cast Iron (GG)

code	type	material	teeth	taper bush	bore max	dp	de	Df	Dm	Di	F	L	R	n° flange	Kg.
TL 28 14M 55	18F	St	28	2012	50	124,78	122,12	127		94	70	32	19	400	2,20
TL 30 14M 55	18F	St	30	2517	60	133,69	130,99	138		100	70	45	12,5	401	2,70
TL 32 14M 55	18F	St	32	2517	60	142,60	139,88	154		108	70	45	12,5	403	3,60
TL 34 14M 55	18F	St	34	2517	60	151,52	148,79	160		110	70	45	12,5	404	4,50
TL 36 14M 55	18F	St	36	2517	60	160,43	157,68	168		120	70	45	12,5	405	5,20
TL 38 14M 55	18F	St	38	2517	60	169,34	166,60	183		130	70	45	12,5	406	6,20
TL 40 14M 55	18F	St	40	2517	60	178,25	175,49	188		138	70	45	12,5	407	6,90
TL 44 14M 55	18F	St	44	3020	75	196,08	193,28	211		155	70	51	9,5	411	8,60
TL 48 14M 55	18F	St	48	3020	75	213,90	211,11	226		170	70	51	9,5	412	10,50
TL 56 14M 55	18F	GG	56	3020	75	249,55	246,76	256		208	70	51	9,5	416	13,50
TL 64 14M 55	19F	GG	64	3020	75	285,21	282,41	296	170	240	70	51	9,5	418	14,50
TL 72 14M 55	19	GG	72	3020	75	320,86	318,06		170	280	70	51	9,5		16,30
TL 80 14M 55	20	GG	80	3020	75	356,51	353,71		170	315	70	51	9,5		17,50
TL 90 14M 55	20	GG	90	3020	75	401,07	398,28		170	360	70	51	9,5		20,00
TL112 14M 55	20	GG	112	3020	75	499,11	496,32		170	457	70	51	9,5		28,20
TL144 14M 55	20	GG	144	3020	75	641,71	638,92		170	600	70	51	9,5		36,00
TL168 14M 55	20	GG	168	3020	75	748,66	745,87		170	706	70	51	9,5		48,50
TL192 14M 55	20	GG	192	3020	75	855,62	852,82		170	813	70	51	9,5		52,00

### 14M

PITCH 14 mm  
FOR BELT WIDTH 85 mm

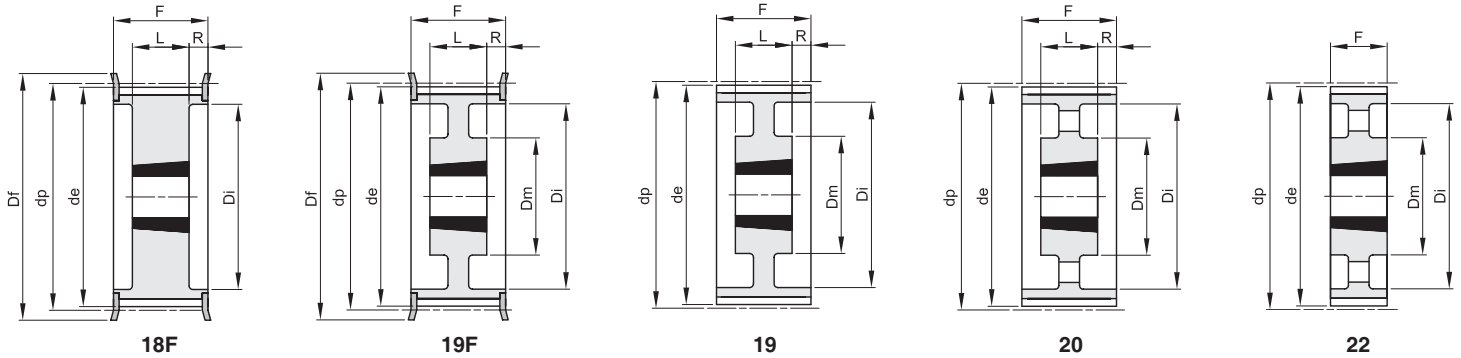

Материал Стомана (St) / Material Steel (St)

Материал Чугун (GG) / Material Cast Iron (GG)

code	type	material	teeth	taper bush	bore max	dp	de	Df	Dm	Di	F	L	R	n° flange	Kg.
TL 28 14M 85	18F	St	28	2517	60	124,78	122,12	127		98	102	45	28,5	400	2,70
TL 30 14M 85	18F	St	30	2517	60	133,69	130,99	138		100	102	45	28,5	401	3,80
TL 32 14M 85	18F	St	32	2517	60	142,60	139,88	154		108	102	45	28,5	403	4,70
TL 34 14M 85	18F	St	34	2517	60	151,52	148,79	160		110	102	45	28,5	404	6,00
TL 36 14M 85	18F	St	36	3020	75	160,43	157,68	168		125	102	51	25,5	405	5,70
TL 38 14M 85	18F	St	38	3020	75	169,34	166,60	183		130	102	51	25,5	406	6,80
TL 40 14M 85	18F	St	40	3020	75	178,25	175,49	188		138	102	51	25,5	407	8,00
TL 44 14M 85	18F	St	44	3030	75	196,08	193,28	211		155	102	76	13	411	11,70
TL 48 14M 85	18F	St	48	3030	75	213,90	211,11	226		170	102	76	13	412	15,00
TL 56 14M 85	18F	GG	56	3525	90	249,55	246,76	256		210	102	65	18,5	416	19,00
TL 64 14M 85	19F	GG	64	3525	90	285,21	282,41	296	190	240	102	65	18,5	418	23,50
TL 72 14M 85	19	GG	72	3525	90	320,86	318,06		190	280	102	65	18,5		25,00
TL 80 14M 85	20	GG	80	3525	90	356,51	353,71		190	315	102	65	18,5		26,00
TL 90 14M 85	20	GG	90	3525	90	401,07	398,28		190	360	102	65	18,5		28,00
TL112 14M 85	20	GG	112	3525	90	499,11	496,32		190	457	102	65	18,5		36,00
TL144 14M 85	20	GG	144	3525	90	641,71	638,92		190	600	102	65	18,5		48,00
TL168 14M 85	20	GG	168	3525	90	748,66	745,87		190	706	102	65	18,5		60,00
TL192 14M 85	22	GG	192	4040	100	855,62	852,82		230	813	102	102			85,00



### 14M

PITCH 14 mm  
FOR BELT WIDTH 115 mm

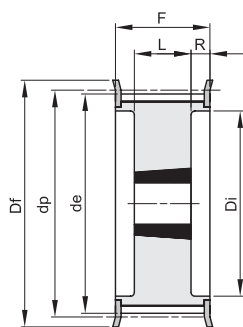

18F

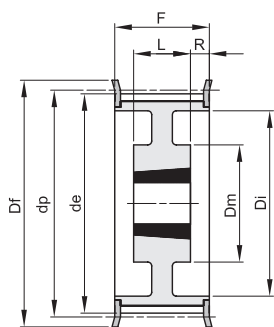

19F

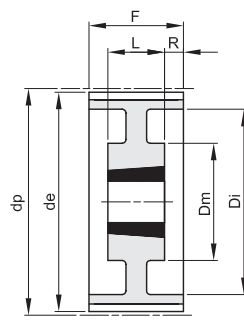

19

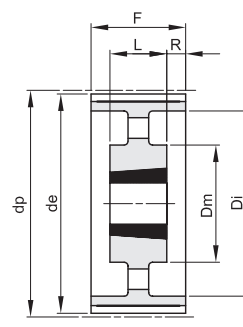

20

Материал Стомана (St) / Material Steel (St)

Материал Чугун (GG) / Material Cast Iron (GG)

code	type	material	teeth	taper bush	bore max	dp	de	Df	Dm	Di	F	L	R	n° flange	Kg.
TL 28 14M 115	18F	St	28	2517	60	124,78	122,12	127		98	133	45	44	400	3,80
TL 30 14M 115	18F	St	30	2517	60	133,69	130,99	138		100	133	45	44	401	5,00
TL 32 14M 115	18F	St	32	2517	60	142,60	139,88	154		108	133	45	44	403	6,80
TL 34 14M 115	18F	St	34	2517	60	151,52	148,79	160		110	133	45	44	404	6,90
TL 36 14M 115	18F	St	36	3020	75	160,43	157,68	168		125	133	51	41	405	7,00
TL 38 14M 115	18F	St	38	3020	75	169,34	166,60	183		130	133	51	41	406	8,50
TL 40 14M 115	18F	St	40	3020	75	178,25	175,49	188		138	133	51	41	407	9,10
TL 44 14M 115	18F	St	44	3030	75	196,08	193,28	211		155	133	76	28,5	411	13,00
TL 48 14M 115	18F	St	48	3030	75	213,90	211,11	226		170	133	76	28,5	412	16,00
TL 56 14M 115	18F	GG	56	3535	90	249,55	246,76	256		210	133	89	22	416	24,00
TL 64 14M 115	19F	GG	64	3535	90	285,21	282,41	296	190	240	133	89	22	418	32,00
TL 72 14M 115	19	GG	72	3535	90	320,86	318,06		190	280	133	89	22		31,00
TL 80 14M 115	20	GG	80	3535	90	356,51	353,71		190	315	133	89	22		32,00
TL 90 14M 115	20	GG	90	3535	90	401,07	398,28		190	360	133	89	22		37,00
TL112 14M 115	20	GG	112	3535	90	499,11	496,32		190	457	133	89	22		45,00
TL144 14M 115	20	GG	144	4040	100	641,71	638,92		230	600	133	102	15,5		63,00
TL168 14M 115	20	GG	168	4040	100	748,66	745,87		230	706	133	102	15,5		77,50
TL192 14M 115	20	GG	192	4040	100	855,62	852,82		230	813	133	102	15,5		95,00

### 14M

PITCH 14 mm  
FOR BELT WIDTH 170 mm

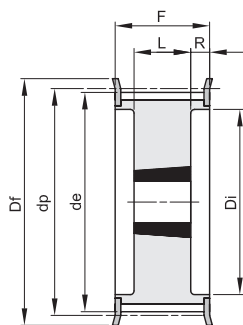

18F

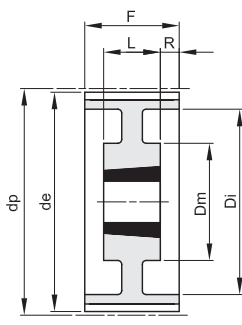

19

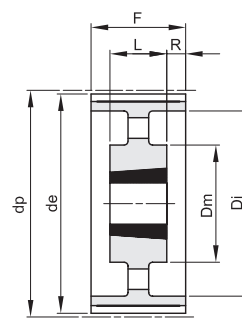

20

Материал Стомана (St) / Material Steel (St)

Материал Чугун (GG) / Material Cast Iron (GG)

code	type	material	teeth	taper bush	bore max	dp	de	Df	Dm	Di	F	L	R	n° flange	Kg.
TL 38 14M 170	18F	St	38	3030	75	169,34	166,60	183		130	187	76	55,5	406	11,70
TL 40 14M 170	18F	St	40	3030	75	178,25	175,49	188		138	187	76	55,5	407	13,00
TL 44 14M 170	18F	St	44	3535	90	196,08	193,28	211		155	187	89	49	411	15,00
TL 48 14M 170	18F	St	48	3535	90	213,90	211,11	226		170	187	89	49	412	19,00
TL 56 14M 170	18F	St	56	3535	90	249,55	246,76	256		210	187	89	49	416	28,50
TL 64 14M 170	18F	GG	64	4040	100	285,21	282,41	296		240	187	102	42,5	418	41,00
TL 72 14M 170	19	GG	72	4040	100	320,86	318,06		230	280	187	102	42,5		47,00
TL 80 14M 170	19	GG	80	4040	100	356,51	353,71		230	315	187	102	42,5		48,00
TL 90 14M 170	20	GG	90	4040	100	401,07	398,28		230	360	187	102	42,5		52,50
TL112 14M 170	20	GG	112	5050	125	499,11	496,32		265	457	187	127	30		74,50
TL144 14M 170	20	GG	144	5050	125	641,71	638,92		265	600	187	127	30		91,00
TL168 14M 170	20	GG	168	5050	125	748,66	745,87		265	706	187	127	30		116,00
TL192 14M 170	20	GG	192	5050	125	855,62	852,82		265	813	187	127	30		134,00

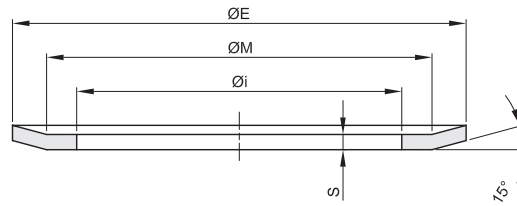

thickness S=0.5mm				thickness S=1.0mm				thickness S=1.5mm				thickness S=2.5mm			
n° flange	Ø E	Ø M	Ø i	n° flange	Ø E	Ø M	Ø i	n° flange	Ø E	Ø M	Ø i	n° flange	Ø E	Ø M	Ø i
100	13	10	6	200	19,5	17,5	12,5	300	36	31	25	400	127	120,2	104,7
101	15	12	8	201	23	17,5	12	301	38	34	28	401	138	130	108
102	16	13	9,5	202	23	20	14	302	42	38	30,5	402	146	138	116
104	18	15	11,5	203	25	22	15	303	44	40	33	403	154	146	122
105	19,5	17,5	12	204	28	24	18	304	48	43,5	37	404	160	150	128
106	23	17,5	12	205	32	28	21,5	305	51	47,5	40	405	168	162	135
107	23	20	14	206	36	31	25	306	54	50,5	43	406	183	170	145
108	25	22	15	207	38	34	28	307	57	53	46	407	188	180	158
109	28	24	18	208	42	38	30,5	308	60	57	47	409	198	188	165
110	32	28	21,5	209	44	40	33	309	63	57	48	410	200	192,8	172
111	36	31	25	210	48	43,5	37	310	66	61,5	52	411	211	198	173
112	38	34	28	211	51	47,5	40	311	71	65	56	412	226	214	190
113	42	38	30,5	212	54	50,5	43	312	75	68,5	60	414	240	224	192
114	48	43,5	37	213	57	53	46	313	79	73,5	64	415	256	240	220
				214	60	57	47	314	83	76,5	68	416	256	247	225
				215	63	57	48	315	87	82,5	72	418	296	287	252
				216	66	61,5	52	316	91	85,5	76				
				217	71	65	56	317	93	89	80				
				218	75	68,5	60	318	97	93	83				
				219	83	76,5	68	319	98	92	79,3				
				220	87	82,5	72	320	103	97	86				
				221	91	85,5	76	321	106	101	90				
				222	93	89	80	322	111	106	94				
				223	97	93	83	323	115	110	99				
				224	106	101	90	325	119	113,5	103				
				225	119	113,5	103	326	123	117,5	107				
				226	131	125,5	115	327	127	122	111				
								328	135	130	119				
								330	140	134,5	123				
								331	143	139	127				
								333	148	143	132				
								334	152	147,5	136				
								335	158	154	142				
								338	168	163	149,5				
								339	184	179	165				
								340	192	187	173				
								342	200	195	181				

N°THEET PULLEY	MXL TH. 0,5	XL TH. 1	L TH. 1,5	H TH. 1,5	XH TH. 2,5	HTD 3M TH. 0,5	HTD 5M TH. 1	HTD 8M TH. 1,5	HTD 14M TH. 2,5	T 2,5 TH. 0,5	T 5 TH. 1	T 10 TH. 1	BAT 5 TH. 1	BAT 10 TH. 1
10		201	300			100					200	206		
11		201	301								201	207		
12	100	203	302			101	202			100	201	208	201	208
13		203	303				203			100	203	209	203	
14	100	204	304	309		102	203			101	203	210	203	210
15	100	204	305	310		104	204			101	204	211	204	211
16	101	205	306	311		104	204			102	205	212	205	212
17		205	307	312			205			104	205	213	205	213
18	102	206	308	313	401	105	205	304		104	205	214	205	214
19		206	309	314	402		205	305		104	206	216	206	216
20	102	207	310	315	403	107	206	306		105	206	216	206	216
21		207	311	316	404	108	207	307		105	207	217	207	217
22	104	208	312	317	405	108	207	308		106	207	218	207	218
23		208	313	318			208	309			208	313	208	313
24	104	209	313	320	406	108	208	310		107	208	219	208	219
25	105	210	314	321	407		209	310		107	209	219	209	219
26	106	210	315	322	409	109	209	311		108	209	220	209	220
27		210	315	323	410		210				210	221	210	221
28	107	211	316	325	411	110	210	312	400	108	210	222	210	222
29		211		326						109	211			
30	107	212	318	327	412	110	211	314	401	109	211	223	211	223
32	108	213	320	328	414	111	212	315	403	110	212	224	212	224
33		213	321	330										
34	108	214	322	331	415		213	316	404	110	213	323	213	323
35		215	322	333				317		110	214			
36	109	216	323	334		112	214	319	405	111	215	225	215	225
37											215			
38	109	217		335			216	320	406	111	216	327	216	327
39		217												
40	110	217	327	338		113	217	321	407	112	216	226	216	226
41		218												
42	110	218	328				218				217		217	330
43		313												
44	111	313	330	339		114	218	325	411	113	218		218	331
45	111		331	340			313			113	313	333		
46											313		313	334
48	111	220	334	342			219	327	412		219	335	219	335
50	112						220			209	220			
52													220	338
56		223					222	333	416				222	339
58													223	340
60	113	320					320			211	320	342	320	342
64							224	338	418					224
65										213				
70	211									215				
72	211	326					225	340		215	225		225	
80											226			
90										219	333			
100										220	338			