

SPZ - 01

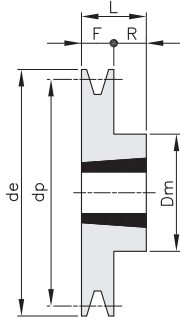

1

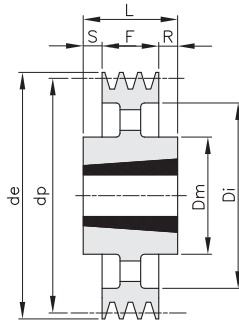

4

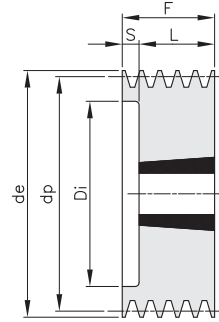

8

Материал Чугун Г20 / Material Cast Iron G20 UNI 5007

type	grooves	dp	de	form	taper bush	bore MAX	Dm	Di	E	F	L	R	S	Kg.
*SPZ 50 01	1	50	54	8	1008	25		26		37	25		12	0,40
*SPZ 56 01	1	56	60	8	1008	25		32		37	25		12	0,50
*SPZ 60 01	1	60	64	1	1008	25				22	22			0,50
SPZ 63 01	1	63	67	1	1108	28	56			16	22	6		0,40
SPZ 67 01	1	67	71	1	1108	28	60			16	22	6		0,50
SPZ 71 01	1	71	75	1	1108	28	60			16	22	6		0,50
SPZ 75 01	1	75	79	1	1108	28	60			16	22	6		0,60
SPZ 80 01	1	80	84	1	1210	32	75			16	25	9		0,60
SPZ 85 01	1	85	89	1	1210	32	80			16	25	9		0,80
SPZ 90 01	1	90	94	1	1210	32	80			16	25	9		0,80
SPZ 95 01	1	95	99	1	1210	32	85			16	25	9		0,90
SPZ 100 01	1	100	104	1	1210	32	85			16	25	9		0,90
SPZ 106 01	1	106	110	1	1610	42	92			16	25	9		1,00
SPZ 112 01	1	112	116	1	1610	42	92			16	25	9		1,10
SPZ 118 01	1	118	122	1	1610	42	92			16	25	9		1,30
SPZ 125 01	1	125	129	1	1610	42	92			16	25	9		1,40
SPZ 132 01	1	132	136	1	1610	42	92			16	25	9		1,50
SPZ 140 01	1	140	144	1	1610	42	92			16	25	9		1,50
SPZ 150 01	1	150	154	1	1610	42	92			16	25	9		1,60
SPZ 160 01	1	160	164	1	1610	42	92			16	25	9		1,70
SPZ 170 01	1	170	174	1	1610	42	92			16	25	9		1,80
SPZ 180 01	1	180	184	4	1610	42	92	152		16	25	9		2,00
SPZ 190 01	1	190	194	4	1610	42	92	162		16	25	9		2,20
SPZ 200 01	1	200	204	4	2012	50	112	171		16	32	16		2,60
SPZ 224 01	1	224	228	4	2012	50	112	195		16	32	16		2,80
SPZ 250 01	1	250	254	4	2012	50	112	221		16	32	8	8	3,20
SPZ 280 01	1	280	284	4	2012	50	112	251		16	32	8	8	3,50
SPZ 315 01	1	315	319	4	2012	50	112	286		16	32	8	8	3,80
SPZ 355 01	1	355	359	4	2012	50	112	326		16	32	8	8	4,20
SPZ 400 01	1	400	404	4	2012	50	112	371		16	32	8	8	6,00
SPZ 450 01	1	450	454	4	2517	65	124	421		16	45	14,5	14,5	11,00

SPZ - 02

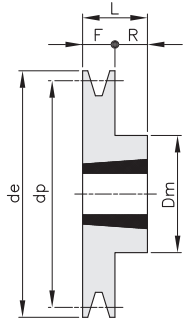

1

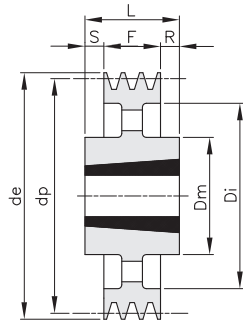

4

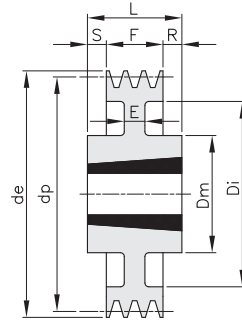

7

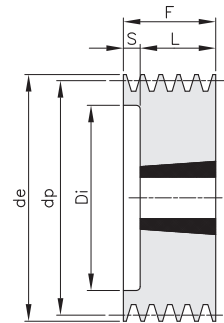

8

Материал Чугун Г20 / Material Cast Iron G20 UNI 5007

type	grooves	dp	de	form	taper	bush	bore MAX	Dm	Di	E	F	L	R	S	Kg.
*SPZ 50 02	2	50	54	8	1008		25		26		50	25		25	0,30
*SPZ 56 02	2	56	60	8	1008		25		32		49	22		27	0,60
SPZ 60 02	2	60	64	8	1108		28		36		49	22		27	0,60
SPZ 63 02	2	63	67	8	1108		28		40		28	22		6	0,50
SPZ 67 02	2	67	71	8	1108		28		42		28	22		6	0,50
SPZ 71 02	2	71	75	8	1108		28		42		28	22		6	0,50
SPZ 75 02	2	75	79	8	1210		32		51		28	25		3	0,60
SPZ 80 02	2	80	84	8	1210		32		51		28	25		3	0,70
SPZ 85 02	2	85	89	8	1610		42		60		28	25		3	0,51
SPZ 90 02	2	90	94	8	1610		42		61		28	25		3	0,80
SPZ 95 02	2	95	99	8	1610		42		66		28	25		3	0,80
SPZ 100 02	2	100	104	8	1610		42		71		28	25		3	1,20
SPZ 106 02	2	106	110	8	1610		42		76		28	25		3	1,20
SPZ 112 02	2	112	116	8	1610		42		83		28	25		3	1,30
SPZ 118 02	2	118	122	8	1610		42		90		28	25		3	1,40
SPZ 125 02	2	125	129	8	1610		42		96		28	25		3	1,70
SPZ 132 02	2	132	136	8	1610		42		103		28	25		3	2,00
SPZ 140 02	2	140	144	8	1610		42		111		28	25		3	2,20
SPZ 150 02	2	150	154	1	2012		50	112			28	32	4		2,30
SPZ 160 02	2	160	164	1	2012		50	112			28	32	4		2,50
SPZ 170 02	2	170	174	1	2012		50	112			28	32	4		2,60
SPZ 180 02	2	180	184	7	2012		50	112	152	10	28	32	4		2,90
SPZ 190 02	2	190	194	7	2012		50	112	162	10	28	32	4		3,30
SPZ 200 02	2	200	204	4	2012		50	112	171		28	32	4		3,50
SPZ 224 02	2	224	228	4	2012		50	112	195		28	32	4		3,70
SPZ 250 02	2	250	254	4	2012		50	112	221		28	32	2	2	3,90
SPZ 280 02	2	280	284	4	2012		50	112	251		28	32	2	2	4,90
SPZ 315 02	2	315	319	4	2012		50	112	286		28	32	2	2	5,80
SPZ 355 02	2	355	359	4	2012		50	112	326		28	32	2	2	6,30
SPZ 400 02	2	400	404	4	2517		65	124	371		28	45	8,5	8,5	7,10
SPZ 450 02	2	450	454	4	2517		65	124	421		28	45	8,5	8,5	9,40
SPZ 500 02	2	500	504	4	2517		65	124	471		28	45	8,5	8,5	10,50

SPZ - 03

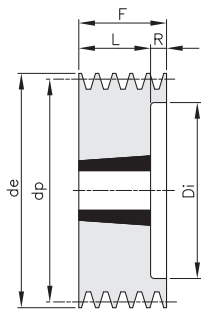

2

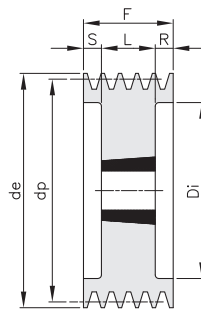

3

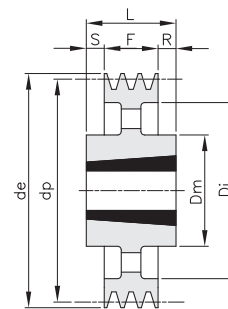

4

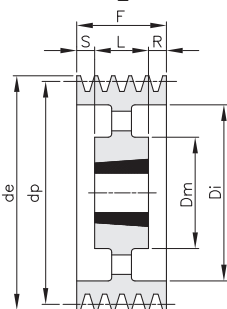

5

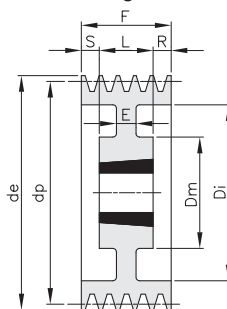

6

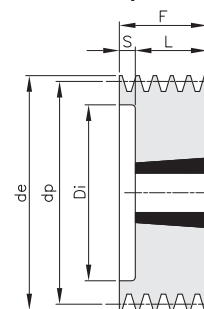

8

Материал Чугун Г20 / Material Cast Iron G20 UNI 5007⁵

type	grooves	dp	de	form taper bush	bore MAX	Dm	Di	E	F	L	R	S	Kg.	
SPZ 63 03	3	63	67	8	1108	28	40	40	22	18	0,50			
SPZ 67 03	3	67	71	8	1108	28	42	40	22	18	0,70			
SPZ 71 03	3	71	75	8	1108	28	42	40	22	18	0,70			
SPZ 75 03	3	75	79	8	1210	32	51	40	25	15	0,80			
SPZ 80 03	3	80	84	8	1210	32	51	40	25	15	0,80			
SPZ 85 03	3	85	89	8	1610	42	60	40	25	15	0,80			
SPZ 90 03	3	90	94	8	1610	42	61	40	25	15	0,90			
SPZ 95 03	3	95	99	8	1610	42	66	40	25	15	1,10			
SPZ 100 03	3	100	104	8	1610	42	71	40	25	15	1,20			
SPZ 106 03	3	106	110	8	1610	42	76	40	25	15	1,40			
SPZ 112 03	3	112	116	8	2012	50	83	40	32	8	1,50			
SPZ 118 03	3	118	122	8	2012	50	90	40	32	8	1,60			
SPZ 125 03	3	125	129	2	2012	50	96	40	32	8	2,00			
SPZ 132 03	3	132	136	2	2012	50	103	40	32	8	2,40			
SPZ 140 03	3	140	144	2	2010	50	111	40	32	8	2,80			
SPZ 150 03	3	150	154	2	2012	50	121	40	32	8	3,40			
SPZ 160 03	3	160	164	2	2012	50	131	40	32	8	3,60			
SPZ 170 03	3	170	174	3	2012	50	141	40	32	4	4	3,70		
SPZ 180 03	3	180	184	6	2012	50	106	151	7	40	32	8	3,70	
SPZ 190 03	3	190	194	6	2012	50	112	161	10	40	32	4	4	4,00
SPZ 200 03	3	200	204	5	2012	50	112	171	40	32	4	4	4,30	
SPZ 224 03	3	224	228	5	2012	50	112	195	40	32	4	4	4,70	
SPZ 250 03	3	250	254	5	2012	50	112	221	40	32	4	4	5,40	
SPZ 280 03	3	280	284	4	2517	65	124	251	40	45	2,5	2,5	6,50	
SPZ 315 03	3	315	319	4	2517	65	124	286	40	45	2,5	2,5	7,80	
SPZ 355 03	3	355	359	4	2517	65	124	326	40	45	2,5	2,5	8,90	
SPZ 400 03	3	400	404	4	2517	65	124	371	40	45	2,5	2,5	9,10	
SPZ 450 03	3	450	454	4	2517	65	124	421	40	45	2,5	2,5	9,70	
SPZ 500 03	3	500	504	4	2517	65	124	471	40	45	2,5	2,5	10,60	
SPZ 630 03	3	630	634	4	3020	75	150	601	40	51	5,5	5,5	15,00	
SPZ 800 03	3	800	804	4	3020	75	150	771	40	51	5,5	5,5	28,50	

SPZ - 04

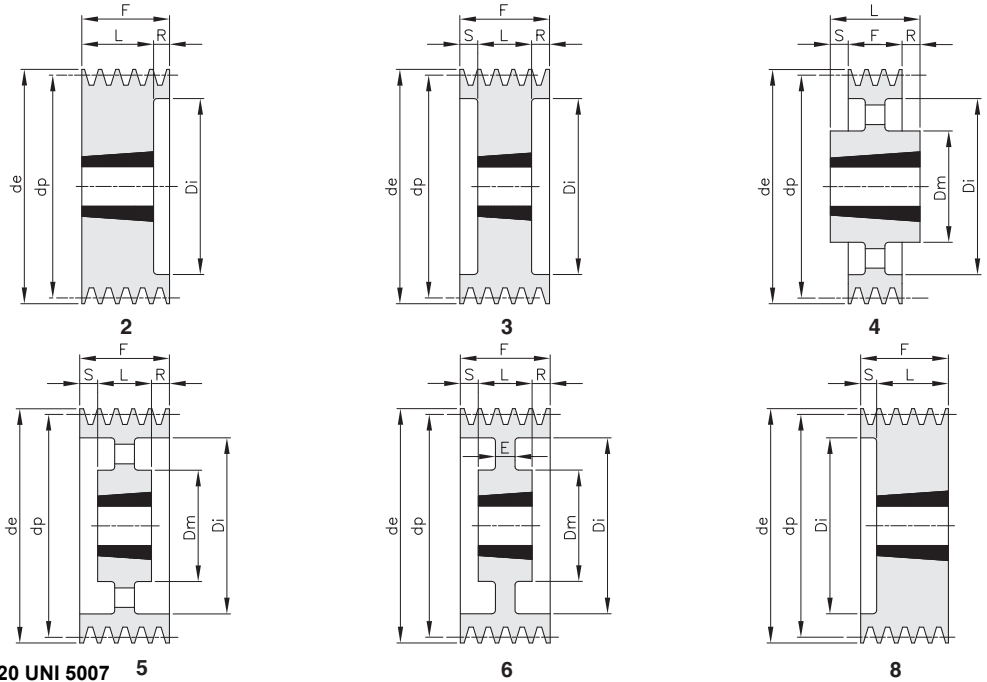

Материал Чугун Г20 / Material Cast Iron G20 UNI 5007

type	grooves	dp	de	form taper bush	bore MAX	Dm	Di	E	F	L	R	S	Kg.	
SPZ 71 04	4	71	75	8	1108	28	42		52	22		30	0,80	
SPZ 80 04	4	80	84	8	1210	32	51		52	25		27	0,90	
SPZ 85 04	4	85	89	8	1610	42	60		52	25		27	1,00	
SPZ 90 04	4	90	94	8	1610	42	61		52	25		27	1,10	
SPZ 95 04	4	95	99	8	1610	42	66		52	25		27	1,20	
SPZ 100 04	4	100	104	8	1610	42	71		52	25		27	1,30	
SPZ 106 04	4	106	110	8	1610	42	76		52	25		27	1,40	
SPZ 112 04	4	112	116	8	2012	50	83		52	32		20	1,60	
SPZ 118 04	4	118	122	8	2012	50	90		52	32		20	1,90	
SPZ 125 04	4	125	129	2	2012	50	96		52	32	20		2,20	
SPZ 132 04	4	132	136	2	2012	50	103		52	32	20		2,60	
SPZ 140 04	4	140	144	2	2012	50	111		52	32	20		3,00	
SPZ 150 04	4	150	154	2	2517	65	121		52	45	7		3,60	
SPZ 160 04	4	160	164	2	2517	65	131		52	45	7		4,50	
SPZ 170 04	4	170	174	2	2517	65	141		52	45	7		4,80	
SPZ 180 04	4	180	184	2	2517	65	151		52	45	7		5,00	
SPZ 190 04	4	190	194	3	2517	65	161		52	45	3,5	3,5	5,10	
SPZ 200 04	4	200	204	6	2517	65	124	171	8	52	45	3,5	3,5	5,20
SPZ 224 04	4	224	228	5	2517	65	124	195		52	45	3,5	3,5	5,90
SPZ 250 04	4	250	254	5	2517	65	124	221		52	45	3,5	3,5	6,60
SPZ 280 04	4	280	284	5	2517	65	124	251		52	45	3,5	3,5	7,20
SPZ 315 04	4	315	319	5	2517	65	124	286		52	45	3,5	3,5	8,50
SPZ 355 04	4	355	359	5	2517	65	124	326		52	45	3,5	3,5	9,40
SPZ 400 04	4	400	404	5	2517	65	124	371		52	45	3,5	3,5	11,20
SPZ 450 04	4	450	454	5	3020	75	146	421		52	45	0,5	0,5	11,60
SPZ 500 04	4	500	504	5	3020	75	146	471		52	51	0,5	0,5	12,40
SPZ 630 04	4	630	634	4	3030	75	146	601		52	76	12	12	18,00
SPZ 800 04	4	800	804	4	3030	75	146	771		52	76	12	12	38,00

SPZ - 05

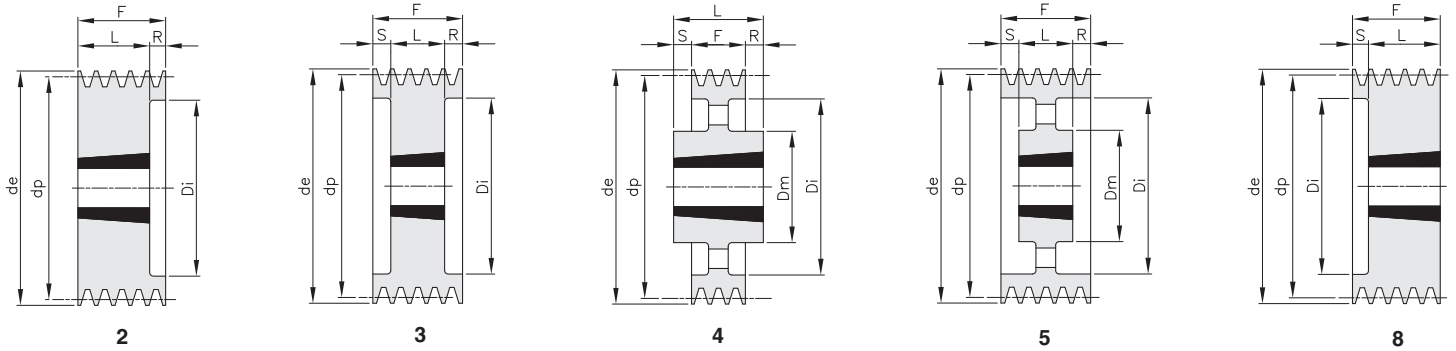

Материал Чугун Г20 / Material Cast Iron G20 UNI 5007

type	grooves	dp	de	form taper bush	bore MAX	Dm	Di	E	F	L	R	S	Kg.
SPZ 85 05	5	85	89	8	1610	42	60		64	25		39	1,20
SPZ 90 05	5	90	94	8	1610	42	61		64	25		39	1,40
SPZ 95 05	5	95	99	8	1610	42	66		64	25		39	1,50
SPZ 100 05	5	100	104	8	2012	50	71		64	32		32	1,60
SPZ 106 05	5	106	110	8	2012	50	76		64	32		32	1,80
SPZ 112 05	5	112	116	8	2012	50	83		64	32		32	1,90
SPZ 118 05	5	118	122	8	2012	50	90		64	32		32	2,40
SPZ 125 05	5	125	129	8	2012	50	96		64	32		32	2,80
SPZ 132 05	5	132	136	8	2517	65	103		64	45		19	2,80
SPZ 140 05	5	140	144	2	2517	65	111		64	45	19		3,20
SPZ 150 05	5	150	154	2	2517	65	121		64	45	19		3,90
SPZ 160 05	5	160	164	2	2517	65	131		64	45	19		4,70
SPZ 170 05	5	170	174	2	2517	65	141		64	45	19		5,50
SPZ 180 05	5	180	184	2	2517	65	151		64	45	19		6,20
SPZ 190 05	5	190	194	3	2517	65	161		64	45	9,5	9,5	6,40
SPZ 200 05	5	200	204	3	2517	65	171		64	45	9,5	9,5	6,50
SPZ 224 05	5	224	228	5	2517	65	124	195	64	45	9,5	9,5	7,20
SPZ 250 05	5	250	254	5	2517	65	124	221	64	45	9,5	9,5	7,60
SPZ 280 05	5	280	284	5	2517	65	124	251	64	45	9,5	9,5	9,00
SPZ 315 05	5	315	319	5	2517	65	124	286	64	45	9,5	9,5	10,00
SPZ 355 05	5	355	359	5	2517	65	124	326	64	45	9,5	9,5	12,10
SPZ 400 05	5	400	404	5	3020	75	146	371	64	51	6,5	6,5	13,80
SPZ 450 05	5	450	454	5	3020	75	146	421	64	51	6,5	6,5	16,00
SPZ 500 05	5	500	504	4	3030	75	146	471	64	76	6	6	20,50
SPZ 630 05	5	630	634	4	3030	75	146	601	64	76	6	6	27,60
SPZ 800 05	5	800	804	4	3535	90	178	771	64	89	12,5	12,5	44,00

SPZ - 06

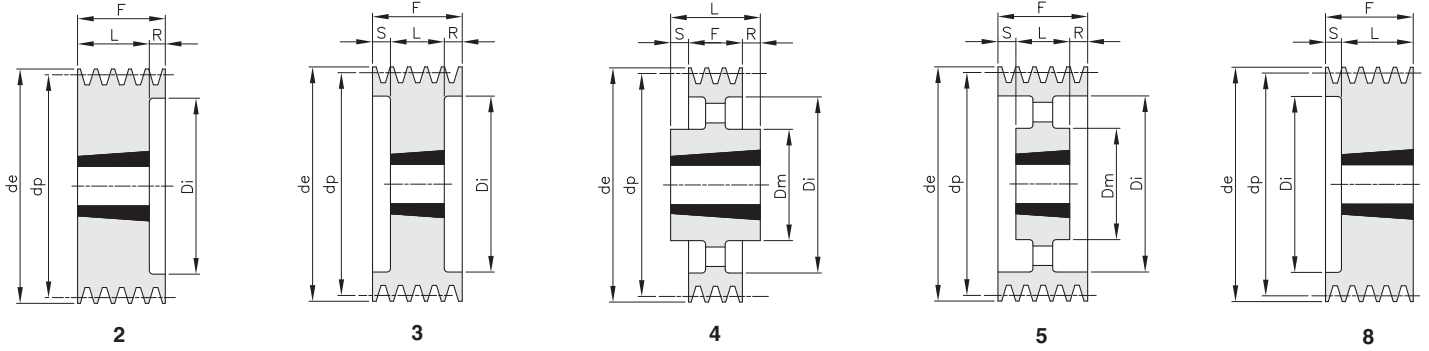

Материал Чугун Г20 / Material Cast Iron G20 UNI 5007

type	grooves	dp	de	form taper bush	bore MAX	Dm	Di	E	F	L	R	S	Kg.
SPZ 90 06	6	90	94	8	1610	42	61		76	25		51	1,50
SPZ 95 06	6	95	99	8	1610	42	66		76	25		51	1,70
SPZ 100 06	6	100	104	8	2012	50	71		76	32		44	1,80
SPZ 106 06	6	106	110	8	2012	50	76		76	32		44	2,00
SPZ 112 06	6	112	116	8	2012	50	83		76	32		44	2,20
SPZ 118 06	6	118	122	8	2517	65	90		76	45		31	2,40
SPZ 125 06	6	125	129	8	2517	65	96		76	45		31	2,90
SPZ 132 06	6	132	136	8	2517	65	103		76	45		31	3,20
SPZ 140 06	6	140	144	2	2517	65	111		76	45	31		3,50
SPZ 150 06	6	150	154	2	2517	65	121		76	45	31		4,50
SPZ 160 06	6	160	164	2	2517	65	131		76	45	31		5,50
SPZ 170 06	6	170	174	2	2517	65	141		76	45	31		6,50
SPZ 180 06	6	180	184	3	2517	65	151		76	45	15,5	15,5	6,50
SPZ 190 06	6	190	194	3	2517	65	161		76	45	15,5	15,5	6,40
SPZ 200 06	6	200	204	3	2517	65	171		76	45	15,5	15,5	6,20
SPZ 224 06	6	224	228	5	2517	65	124	195	76	45	15,5	15,5	7,10
SPZ 250 06	6	250	254	5	2517	65	124	221	76	45	15,5	15,5	8,30
SPZ 280 06	6	280	284	5	2517	65	124	251	76	45	15,5	15,5	9,90
SPZ 315 06	6	315	319	5	2517	65	124	286	76	45	15,5	15,5	11,50
SPZ 355 06	6	355	359	5	2517	65	124	326	76	45	15,5	15,5	14,00
SPZ 400 06	6	400	404	5	3030	75	146	371	76	76			17,60
SPZ 450 06	6	450	454	5	3030	75	146	421	76	76			21,60
SPZ 500 06	6	500	504	5	3030	75	146	471	76	76			23,00
SPZ 630 06	6	630	634	4	3535	90	175	601	76	89	6,5	6,5	33,00
SPZ 800 06	6	800	804	4	3535	90	178	771	76	89	6,5	6,5	52,00

SPZ - 08

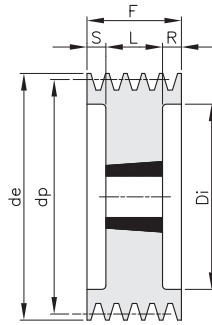

3

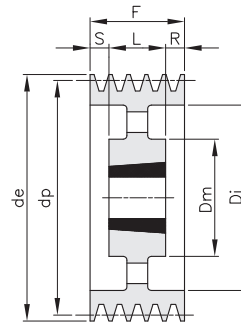

5

Материал Чугун Г20 / Material Cast Iron G20 UNI 5007

type	grooves	dp	de	form	taper bush	bore MAX	Dm	Di	E	F	L	R	S	Kg.
SPZ 140 08	8	140	144	3	2517	65		111		100	45	27,5	27,5	4,00
SPZ 150 08	8	150	154	3	2517	65		121		100	45	27,5	27,5	5,10
SPZ 160 08	8	160	164	3	2517	65		131		100	45	27,5	27,5	5,60
SPZ 180 08	8	180	184	3	2517	65		151		100	45	27,5	27,5	7,10
SPZ 190 08	8	190	194	3	3020	75		161		100	51	24,5	24,5	8,00
SPZ 200 08	8	200	204	3	3020	75		171		100	51	24,5	24,5	9,30
SPZ 224 08	8	224	228	3	3020	75		195		100	51	24,5	24,5	11,80
SPZ 250 08	8	250	254	5	3020	75	146	221		100	51	24,5	24,5	10,50
SPZ 280 08	8	280	284	5	3020	75	146	251		100	51	24,5	24,5	10,80
SPZ 355 08	8	355	359	5	3030	75	146	326		100	76	12	12	16,00
SPZ 400 08	8	400	404	5	3030	75	146	371		100	76	12	12	18,20
SPZ 450 08	8	450	454	5	3535	90	175	421		100	89	5,5	5,5	24,00
SPZ 500 08	8	500	504	5	3535	90	175	471		100	89	5,5	5,5	25,00

SPA - 01

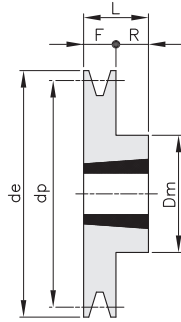

1

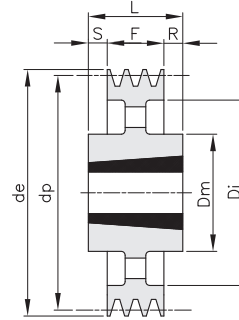

4

Материал Чугун Г20 / Material Cast Iron G20 UNI 5007

type	grooves	dp	de	form taper bush	bore MAX	Dm	Di	E	F	L	R	S	Kg.
SPA 63 01	1	63	68,5	1	1008	25	56		20	22	2		0,26
SPA 67 01	1	67	72,5	1	1108	28	56		20	22	2		0,29
SPA 71 01	1	71	76,5	1	1108	28	60		20	22	2		0,50
SPA 75 01	1	75	80,5	1	1108	28	60		20	22	2		0,60
SPA 80 01	1	80	85,5	1	1210	32	75		20	25	5		0,60
SPA 85 01	1	85	90,5	1	1210	32	80		20	25	5		0,70
SPA 90 01	1	90	95,5	1	1210	32	80		20	25	5		0,70
SPA 95 01	1	95	100,5	1	1210	32	85		20	25	5		0,80
SPA 100 01	1	100	105,5	1	1610	42	85		20	25	5		0,90
SPA 106 01	1	106	111,5	1	1610	42	92		20	25	5		1,00
SPA 112 01	1	112	117,5	1	1610	42	92		20	25	5		1,20
SPA 118 01	1	118	123,5	1	1610	42	92		20	25	5		1,30
SPA 125 01	1	125	130,5	1	1610	42	92		20	25	5		1,40
SPA 132 01	1	132	137,5	1	1610	42	92		20	25	5		1,50
SPA 140 01	1	140	145,5	1	1610	42	92		20	25	5		1,60
SPA 150 01	1	150	155,5	1	1610	42	92		20	25	5		1,70
SPA 160 01	1	160	165,5	1	1610	42	92		20	25	5		2,00
SPA 170 01	1	170	175,5	1	1610	42	92		20	25	5		1,80
SPA 180 01	1	180	185,5	4	1610	42	92	145	20	25	5		1,90
SPA 190 01	1	190	195,5	4	1610	42	92	156	20	25	5		2,50
SPA 200 01	1	200	205,5	4	2012	50	108	165	20	32	12		2,80
SPA 212 01	1	212	217,5	4	2012	50	110	177	20	32	12		2,90
SPA 224 01	1	224	229,5	4	2012	50	112	189	20	32	12		3,00
SPA 236 01	1	236	241,5	4	2012	50	112	202	20	32	12		3,20
SPA 250 01	1	250	255,5	4	2012	50	112	215	20	32	6	6	3,60
SPA 280 01	1	280	285,5	4	2012	50	112	245	20	32	12		4,20
SPA 300 01	1	300	305,5	4	2012	50	112	265	20	32	12		4,30
SPA 315 01	1	315	320,5	4	2012	50	112	280	20	32	12		5,20
SPA 355 01	1	355	360,5	4	2012	50	112	320	20	32	12		5,90
SPA 400 01	1	400	405,5	4	2012	50	112	365	20	32	12		6,30
SPA 450 01	1	450	455,5	4	2012	50	112	415	20	32	12		6,80
SPA 500 01	1	500	505,5	4	2517	65	124	465	20	45	25		8,30
SPA 630 01	1	630	635,5	4	2517	65	124	595	20	45	25		12,50

SPA - 02

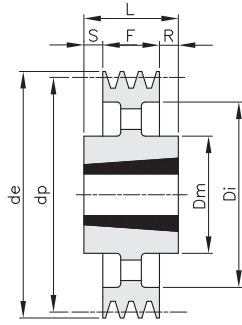

4

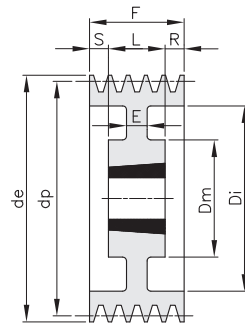

6

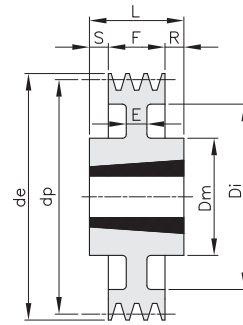

7

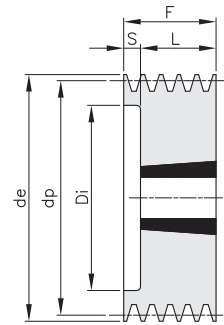

8

Материал Чугун Г20 / Material Cast Iron G20 UNI 5007

type	groves	dp	de	form	taper	bush	bore MAX	Dm	Di	E	F	L	R	S	Kg.
*SPA 63 02	2	63	68,5	8	1008	25			32,5	35	22			13	0,50
SPA 67 02	2	67	72,5	8	1108	28			37	35	22			13	0,60
SPA 71 02	2	71	76,5	8	1108	28			40	35	22			13	0,60
SPA 75 02	2	75	80,5	8	1108	28			44	35	25			13	0,70
SPA 80 02	2	80	85,5	8	1210	32			50	35	25			10	0,70
SPA 85 02	2	85	90,5	8	1210	32			55	35	25			10	0,80
SPA 90 02	2	90	95,5	8	1610	42			59	35	25			10	0,90
SPA 95 02	2	95	100,5	8	1610	42			63	35	25			10	1,00
SPA 100 02	2	100	105,5	8	1610	42			66	35	25			10	1,00
SPA 106 02	2	106	111,5	8	1610	42			72	35	25			10	1,20
SPA 112 02	2	112	117,5	8	1610	42			78	35	25			10	1,40
SPA 118 02	2	118	123,5	8	1610	42			84	35	25			10	1,70
SPA 125 02	2	125	130,5	8	1610	42			91	35	25			10	1,90
SPA 132 02	2	132	137,5	8	2012	50			98	35	32			3	2,10
SPA 140 02	2	140	145,5	8	2012	50			106	35	32			3	2,60
SPA 150 02	2	150	155,5	8	2012	50			116	35	32			3	3,20
SPA 160 02	2	160	165,5	8	2012	50			125	35	32			3	3,60
SPA 170 02	2	170	175,5	8	2012	50			135	35	32			3	4,00
SPA 180 02	2	180	185,5	6	2012	50	108	146	10	35	32	1,5	1,5		4,07
SPA 190 02	2	190	195,5	6	2012	50	108	156	10	35	32	1,5	1,5		4,40
SPA 200 02	2	200	205,5	7	2517	65	123	163	10	35	45	5	5		4,50
SPA 212 02	2	212	217,5	4	2517	65	123	177		35	45	5	5		4,70
SPA 224 02	2	224	229,5	4	2517	65	124	189		35	45	10			5,00
SPA 236 02	2	236	241,5	4	2517	65	124	202		35	45	10			5,40
SPA 250 02	2	250	255,5	4	2517	65	124	215		35	45	5	5		5,60
SPA 280 02	2	280	285,5	4	2517	65	124	245		35	45	10			6,20
SPA 300 02	2	300	305,5	4	2517	65	124	265		35	45	10			6,80
SPA 315 02	2	315	320,5	4	2517	65	124	280		35	45	10			7,20
SPA 355 02	2	355	360,5	4	2517	65	124	320		35	45	10			9,40
SPA 400 02	2	400	405,5	4	2517	65	124	365		35	45	10			10,00
SPA 450 02	2	450	455,5	4	2517	65	124	415		35	45	10			10,50
SPA 500 02	2	500	505,5	4	2517	65	124	465		35	45	10			11,00
SPA 630 02	2	630	635,5	4	3020	75	159	595		35	51	8	8		20,50

SPA - 03

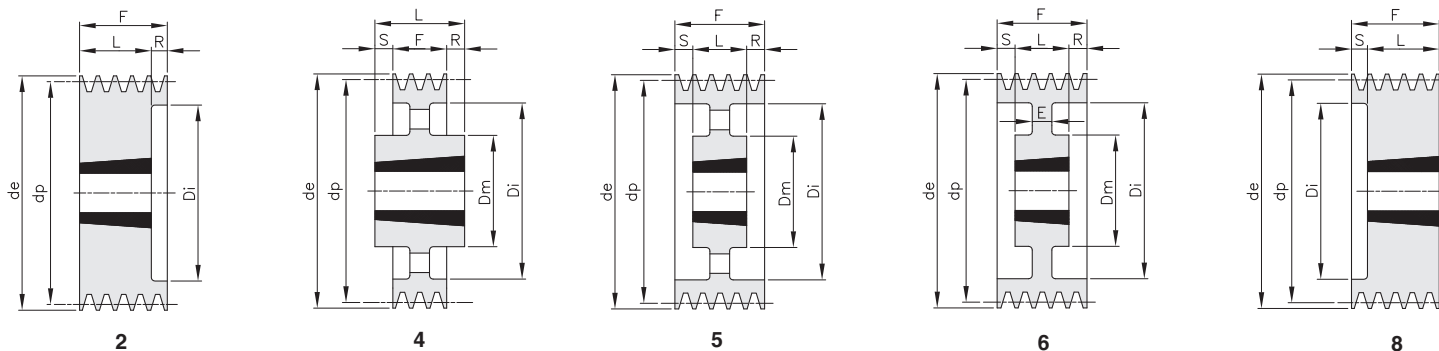

Материал Чугун G20 / Material Cast Iron G20 UNI 5007

type	grooves	dp	de	form taper bush	bore MAX	Dm	Di	E	F	L	R	S	Kg.	
SPA 71 03	3	71	76,5	8	1108	28	40		50	22		28	0,80	
SPA 75 03	3	75	80,5	8	1108	28	44		50	22		28	0,90	
SPA 80 03	3	80	85,5	8	1210	32	50		50	25		25	1,10	
SPA 85 03	3	85	90,5	8	1210	32	55		50	25		25	1,20	
SPA 90 03	3	90	95,5	8	1610	42	59		50	25		25	1,30	
SPA 95 03	3	95	100,5	8	1610	42	63		50	25		25	1,50	
SPA 100 03	3	100	105,5	2	1610	42	66		50	25	25		1,80	
SPA 106 03	3	106	111,5	2	1610	42	72		50	25	25		2,10	
SPA 112 03	3	112	117,5	8	2012	50	78		50	32		18	2,30	
SPA 118 03	3	118	123,5	2	2012	50	84		50	32	18		2,50	
SPA 125 03	3	125	130,5	2	2012	50	91		50	32	18		2,70	
SPA 132 03	3	132	137,5	2	2012	50	98		50	32	18		2,90	
SPA 140 03	3	140	145,5	8	2517	65	106		50	45		5	3,20	
SPA 150 03	3	150	155,5	8	2517	65	116		50	45		5	3,50	
SPA 160 03	3	160	165,5	8	2517	65	125		50	45		5	4,50	
SPA 170 03	3	170	175,5	8	2517	65	135		50	45		5	5,00	
SPA 180 03	3	180	185,5	8	2517	65	146		50	45		5	5,50	
SPA 190 03	3	190	195,5	8	2517	65	156		50	45		5	6,30	
SPA 200 03	3	200	205,5	6	2517	65	123	165	20	50	45	2,5	2,5	5,80
SPA 212 03	3	212	217,5	5	2517	65	123	177		50	45	2,5	2,5	6,00
SPA 224 03	3	224	229,5	5	2517	65	124	189		50	45	2,5	2,5	6,30
SPA 236 03	3	236	241,5	5	2517	65	124	202		50	45	2,5	2,5	6,60
SPA 250 03	3	250	255,5	5	2517	65	124	215		50	45	2,5	2,5	7,30
SPA 280 03	3	280	285,5	5	2517	65	124	245		50	45	2,5	2,5	8,00
SPA 300 03	3	300	305,5	4	3020	75	159	265		50	51	0,5	0,5	9,10
SPA 315 03	3	315	320,5	4	3020	75	159	280		50	51	0,5	0,5	9,40
SPA 355 03	3	355	360,5	4	3020	75	159	320		50	51	0,5	0,5	11,50
SPA 400 03	3	400	405,5	4	3020	75	159	365		50	51	1		13,30
SPA 450 03	3	450	455,5	4	3020	75	159	415		50	51	1		14,20
SPA 500 03	3	500	505,5	4	3020	75	159	465		50	51	1		16,10
SPA 560 03	3	560	565,5	4	3020	75	159	525		50	51	1		18,00
SPA 630 03	3	630	635,5	4	3020	75	159	595		50	51	1		20,00
SPA 800 03	3	800	805,5	4	3535	90	175	765		50	89	19,5	19,5	34,50
SPA1000 03	3	1000	1005,5	4	3535	90	175	965		50	89	19,5	19,5	49,30

SPA - 04

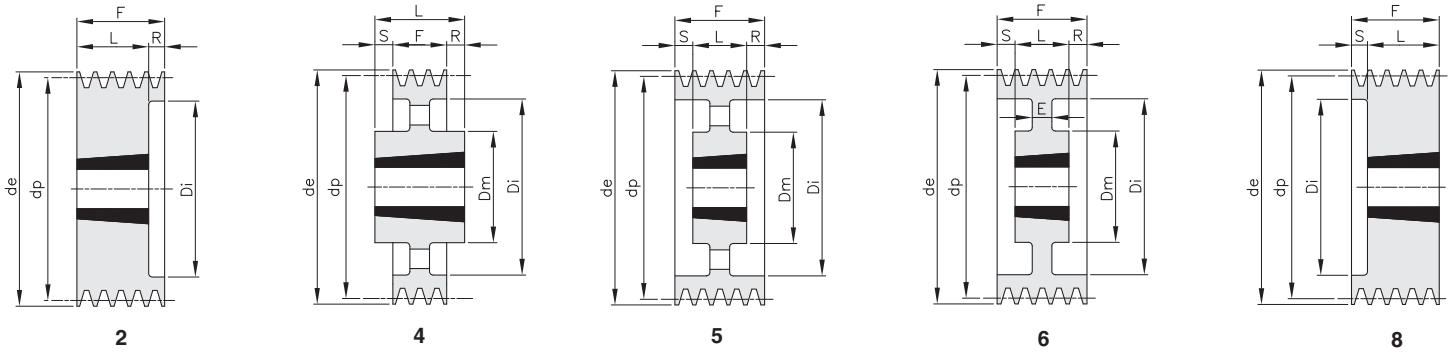

Материал Чугун Г20 / Material Cast Iron G20 UNI 5007

type	grooves	dp	de	form taper bush	bore MAX	Dm	Di	E	F	L	R	S	Kg.
SPA 90 04	4	90	95,5	8	1615	42	59		65	38		27	1,40
SPA 95 04	4	95	100,5	8	1615	42	63		65	38		27	1,60
SPA 100 04	4	100	105,5	2	1615	42	66		65	38	27		1,80
SPA 106 04	4	106	111,5	8	2012	50	72		65	32		33	2,10
SPA 112 04	4	112	117,5	8	2012	50	78		65	32		33	2,50
SPA 118 04	4	118	123,5	2	2012	50	84		65	32	33		2,80
SPA 125 04	4	125	130,5	2	2012	50	91		65	32	33		3,00
SPA 132 04	4	132	137,5	2	2517	65	98		65	45	20		3,20
SPA 140 04	4	140	145,5	2	2517	65	106		65	45	20		3,50
SPA 150 04	4	150	155,5	2	2517	65	116		65	45	20		3,90
SPA 160 04	4	160	165,5	2	2517	65	125		65	45	20		4,30
SPA 170 04	4	170	175,5	2	2517	65	135		65	45	20		5,80
SPA 180 04	4	180	185,5	2	2517	65	146		65	45	20		6,20
SPA 190 04	4	190	195,5	2	2517	65	156		65	45	20		6,80
SPA 200 04	4	200	205,5	2	3020	75	165		65	51	14		7,50
SPA 212 04	4	212	217,5	2	3020	75	177		65	51	14		8,40
SPA 224 04	4	224	229,5	2	3020	75	189		65	51	14		8,80
SPA 236 04	4	236	241,5	6	3020	75	159	20	65	51	14		9,80
SPA 250 04	4	250	255,5	5	3020	75	159	215	65	51	7	7	10,00
SPA 280 04	4	280	285,5	5	3020	75	159	245	65	51	7	7	11,50
SPA 300 04	4	300	305,5	5	3020	75	159	265	65	51	7	7	12,40
SPA 315 04	4	315	320,5	5	3020	75	159	280	65	51	7	7	12,90
SPA 355 04	4	355	360,5	5	3020	75	159	320	65	51	7	7	13,50
SPA 400 04	4	400	405,5	5	3020	75	159	365	65	51	7	7	14,00
SPA 450 04	4	450	455,5	5	3020	75	159	415	65	51	7	7	15,80
SPA 500 04	4	500	505,5	5	3020	75	159	465	65	51	7	7	23,00
SPA 560 04	4	560	565,5	4	3535	90	175	525	65	89	12	12	24,50
SPA 630 04	4	630	635,5	4	3535	90	175	595	65	89	12	12	30,00
SPA 800 04	4	800	805,5	4	3535	90	175	765	65	89	12	12	43,20
SPA1000 04	4	1000	1005,5	4	4040	100	210	965	65	102	18,5	18,5	69,00

SPA - 05

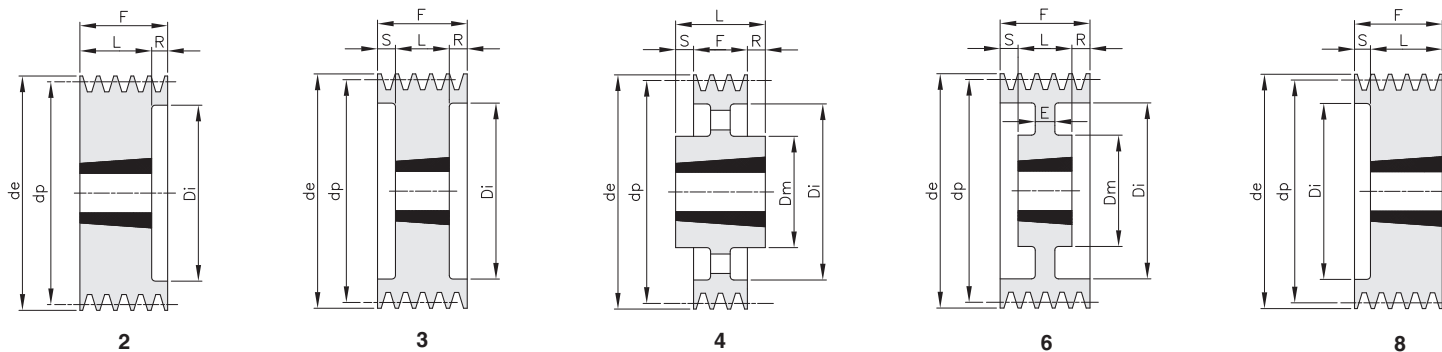

Материал Чугун Г20 / Material Cast Iron G20 UNI 5007

type	grooves	dp	de	form taper bush	bore MAX	Dm	Di	E	F	L	R	S	Kg.
SPA 100 05	5	100	105,5	2	1615	42	66		80	38	42		2,10
SPA 106 05	5	106	111,5	8	2012	50	72		80	32		48	2,30
SPA 112 05	5	112	117,5	8	2012	50	78		80	32		48	2,50
SPA 118 05	5	118	123,5	2	2012	50	84		80	32	48		2,80
SPA 125 05	5	125	130,5	3	2012	50	91		80	32	24	24	3,00
SPA 132 05	5	132	137,5	3	2517	65	98		80	45	17,5	17,5	3,50
SPA 140 05	5	140	145,5	3	2517	65	106		80	45	17,5	17,5	3,90
SPA 150 05	5	150	155,5	3	2517	65	116		80	45	17,5	17,5	4,40
SPA 160 05	5	160	165,5	3	2517	65	125		80	45	17,5	17,5	5,70
SPA 170 05	5	170	175,5	3	2517	65	135		80	45	17,5	17,5	6,30
SPA 180 05	5	180	185,5	3	3020	75	146		80	51	14,5	14,5	6,90
SPA 190 05	5	190	195,5	2	3020	75	156		80	51	29		7,70
SPA 200 05	5	200	205,5	3	3020	75	168		80	51	14,5	14,5	9,00
SPA 212 05	5	212	217,5	2	3020	75	177		80	51	29		9,80
SPA 224 05	5	224	229,5	2	3020	75	189		80	51	29		10,20
SPA 236 05	5	236	241,5	2	3020	75	202		80	51	29		11,20
SPA 250 05	5	250	255,5	6	3020	75	215	20	80	51	14,5	14,5	12,40
SPA 280 05	5	280	285,5	4	3535	90	245		80	89	4,5	4,5	15,00
SPA 300 05	5	300	305,5	4	3535	90	265		80	89	4,5	4,5	16,50
SPA 315 05	5	315	320,5	4	3535	90	280		80	89	4,5	4,5	18,10
SPA 355 05	5	355	360,5	4	3535	90	320		80	89	4,5	4,5	19,20
SPA 400 05	5	400	405,5	4	3535	90	365		80	89	4,5	4,5	21,50
SPA 450 05	5	450	455,5	4	3535	90	415		80	89	4,5	4,5	23,00
SPA 500 05	5	500	505,5	4	3535	90	465		80	89	4,5	4,5	26,50
SPA 560 05	5	560	565,5	4	3535	90	525		80	89	4,5	4,5	30,00
SPA 630 05	5	630	635,5	4	3535	90	595		80	89	4,5	4,5	34,50
SPA 800 05	5	800	805,5	4	4040	100	765		80	102	11	11	55,50
SPA1000 05	5	1000	1005,5	4	4545	110	965		80	114	17	17	80,00

SPA - 06

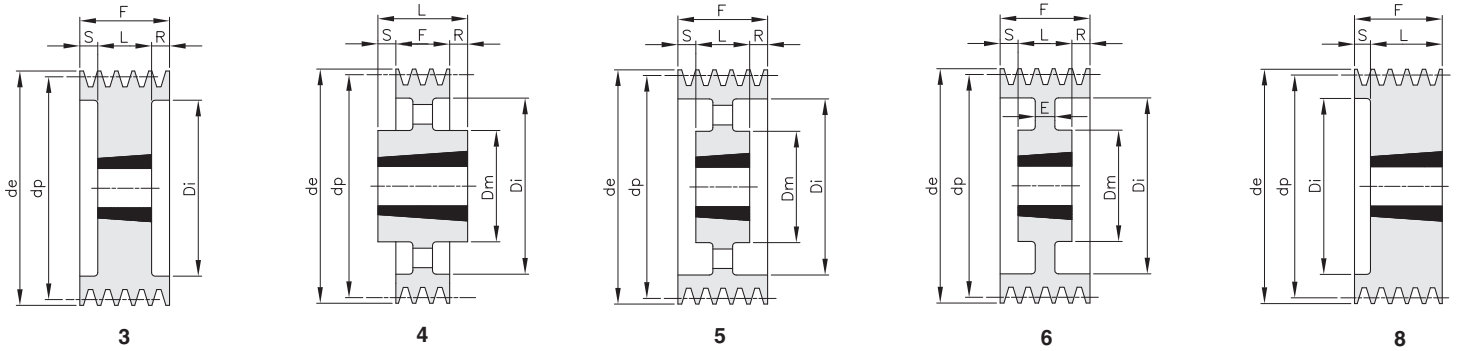

Материал Чугун Г20 / Material Cast Iron G20 UNI 5007

type	grooves	dp	de	form taper bush	bore MAX	Dm	Di	E	F	L	R	S	Kg.	
SPA 100 06	6	100	105,5	3	1610	42	66		95	25	40	30	2,50	
SPA 106 06	6	106	111,5	8	2012	50	72		95	32		63	2,60	
SPA 112 06	6	112	117,5	8	2012	50	78		95	32		63	2,90	
SPA 118 06	6	118	123,5	8	2012	50	84		95	32		63	3,30	
SPA 125 06	6	125	130,5	3	2012	50	91		95	32	31,5	31,5	3,50	
SPA 132 06	6	132	137,5	3	2517	65	98		95	45	25	25	3,80	
SPA 140 06	6	140	145,5	3	2517	65	106		95	45	25	25	4,10	
SPA 150 06	6	150	155,5	3	2517	65	116		95	45	25	25	4,90	
SPA 160 06	6	160	165,5	3	2517	65	125		95	45	25	25	5,70	
SPA 180 06	6	180	185,5	3	3020	75	146		95	51	22	22	8,50	
SPA 200 06	6	200	205,5	3	3020	75	165		95	51	22	22	11,00	
SPA 224 06	6	224	229,5	3	3020	75	189		95	51	22	22	13,40	
SPA 236 06	6	236	241,5	3	3020	75	202		95	51	22	22	14,90	
SPA 250 06	6	250	255,5	6	3020	75	155	215	20	95	51	22	16,40	
SPA 280 06	6	280	285,5	5	3535	90	175	245		95	89	3	3	17,30
SPA 315 06	6	315	320,5	5	3535	90	175	280		95	89	3	3	19,50
SPA 355 06	6	355	360,5	5	3535	90	175	320		95	89	3	3	23,20
SPA 400 06	6	400	405,5	5	3535	90	175	365		95	89	3	3	22,40
SPA 450 06	6	450	455,5	5	3535	90	175	415		95	89	3	3	29,90
SPA 500 06	6	500	505,5	5	3535	90	175	465		95	89	3	3	30,40
SPA 560 06	6	560	565,5	5	3535	90	175	525		95	89	3	3	40,20
SPA 630 06	6	630	635,5	4	4040	100	210	595		95	102	3,5	3,5	48,00
SPA 800 06	6	800	805,5	4	4040	100	210	765		95	102	3,5	3,5	72,00
SPA1000 06	6	1000	1005,5	4	4545	110	242	965		95	114	9,5	9,5	97,00

SPB - 01

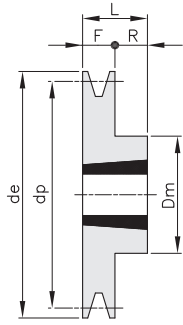

1

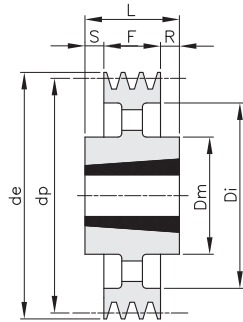

4

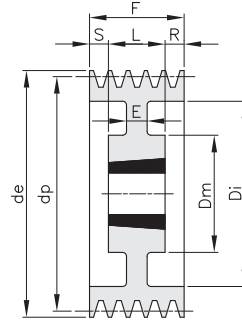

6

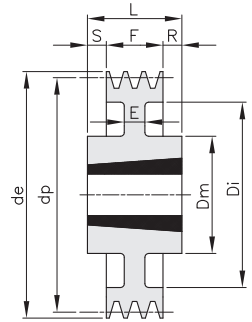

7

Материал Чугун Г20 / Material Cast Iron G20 UNI 5007

type	groves	dp	de	form	taper bush	bore MAX	Dm	Di	E	F	L	R	S	Kg.
SPB 100 01	1	100	107	1	1610	42				25	25			0,90
SPB 106 01	1	106	113	1	1610	42				25	25			1,00
SPB 112 01	1	112	119	1	1610	42				25	25			1,20
SPB 118 01	1	118	125	1	1610	42				25	25			1,30
SPB 125 01	1	125	132	1	1610	42				25	25			1,50
SPB 132 01	1	132	139	1	1610	42				25	25			1,70
SPB 140 01	1	140	147	1	1610	42				25	25			1,80
SPB 150 01	1	150	157	1	1610	42				25	25			2,10
SPB 160 01	1	160	167	1	1610	42				25	25			2,50
SPB 170 01	1	170	177	1	1610	42				25	25			2,90
SPB 180 01	1	180	187	6	1610	42	90	132	12	25	25			3,20
SPB 190 01	1	190	197	7	2012	50	104	147	12	25	32	3,5	3,5	3,80
SPB 200 01	1	200	207	4	2012	50	104	157		25	32	3,5	3,5	4,20
SPB 212 01	1	212	219	4	2012	50	104	169		25	32	3,5	3,5	4,40
SPB 224 01	1	224	231	4	2012	50	104	181		25	32	3,5	3,5	4,70
SPB 236 01	1	236	243	4	2012	50	104	193		25	32	3,5	3,5	4,60
SPB 250 01	1	250	257	4	2012	50	104	207		25	32	3,5	3,5	5,30
SPB 280 01	1	280	287	4	2012	50	104	237		25	32	3,5	3,5	6,00
SPB 300 01	1	300	307	4	2012	50	104	258		25	32	3,5	3,5	6,50
SPB 315 01	1	315	322	4	2012	50	104	272		25	32	3,5	3,5	7,00

SPB - 02

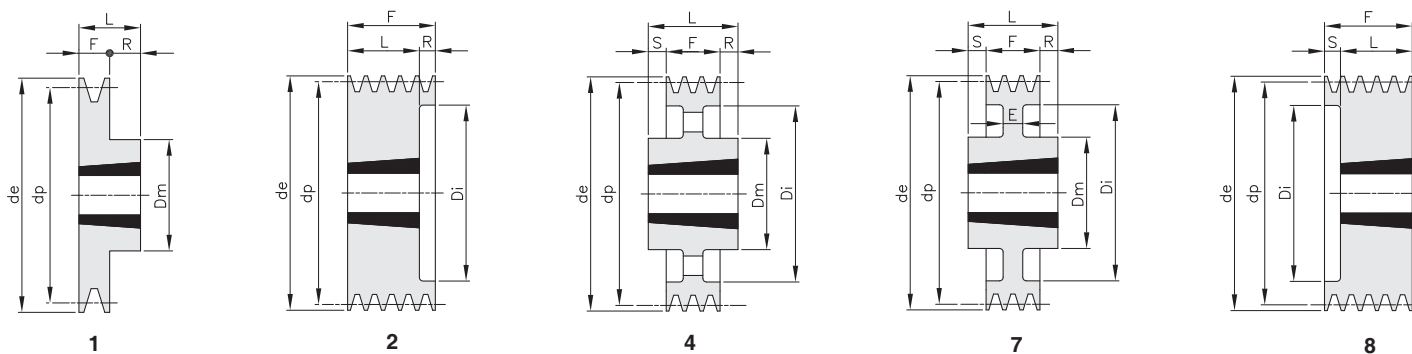

Материал Чугун Г20 / Material Cast Iron G20 UNI 5007

type	grooves	dp	de	form	taper	bush	bore MAX	Dm	Di	E	F	L	R	S	Kg.
SPB 100 02	2	100	107	8	1610		42		62		44	25		19	1,40
SPB 106 02	2	106	113	8	1610		42		67		44	25		19	1,60
SPB 112 02	2	112	119	8	1610		42		72		44	25		19	1,70
SPB 118 02	2	118	125	2	1610		42		78		44	25	19		1,80
SPB 125 02	2	125	132	2	2012		50		82		44	32	12		1,90
SPB 132 02	2	132	139	2	2012		50		89		44	32	12		2,50
SPB 140 02	2	140	147	2	2012		50		97		44	32	12		2,70
SPB 150 02	2	150	157	2	2012		50		107		44	32	12		3,20
SPB 160 02	2	160	167	2	2012		50		117		44	32	12		3,80
SPB 170 02	2	170	177	2	2012		50		127		44	32	12		4,80
SPB 180 02	2	180	187	1	2517		65	120			44	45	1		6,30
SPB 190 02	2	190	197	1	2517		65	120			44	45	1		7,20
SPB 200 02	2	200	207	1	2517		65	117			44	45	1		8,20
SPB 212 02	2	212	219	7	2517		65	117	169	15	44	45	1		5,40
SPB 224 02	2	224	231	4	2517		65	117	181		44	45	1		5,90
SPB 236 02	2	236	243	4	2517		65	117	193		44	45	1		6,60
SPB 250 02	2	250	257	4	2517		65	125	207		44	45	1		7,10
SPB 265 02	2	265	272	4	2517		65	125	222		44	45	1		7,20
SPB 280 02	2	280	287	4	2517		65	125	237		44	45	1		7,40
SPB 300 02	2	300	307	4	2517		65	125	257		44	45	1		8,60
SPB 315 02	2	315	322	4	2517		65	125	272		44	45	1		9,90
SPB 335 02	2	335	342	4	2517		65	125	292		44	45	1		11,30
SPB 355 02	2	355	362	4	3020		75	144	312		44	51	3,5	3,5	12,00
SPB 400 02	2	400	407	4	3020		75	150	357		44	51	3,5	3,5	13,00
SPB 450 02	2	450	457	4	3020		75	150	407		44	51	3,5	3,5	13,50
SPB 500 02	2	500	507	4	3020		75	150	457		44	51	3,5	3,5	15,00
SPB 560 02	2	560	567	4	3030		75	150	517		44	76	28	4	17,00
SPB 630 02	2	630	637	4	3030		75	150	587		44	76	16	16	19,30

SPB - 03

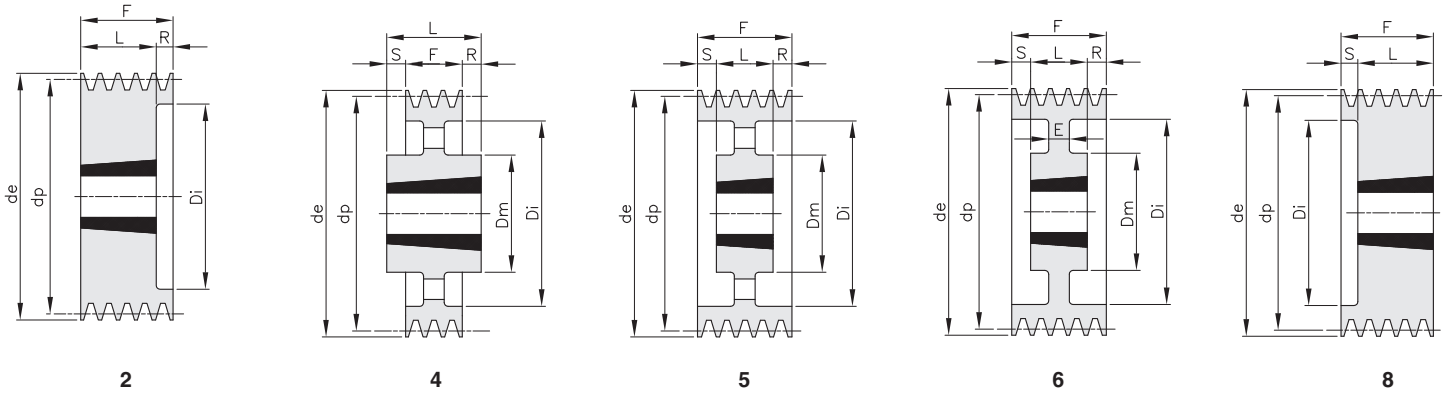

Материал Чугун G20 / Material Cast Iron G20 UNI 5007

type	grooves	dp	de	form	taper bush	bore MAX	Dm	Di	E	F	L	R	S	Kg.
SPB 100 03	3	100	107	8	1610	42		62		63	25		38	1,90
SPB 106 03	3	106	113	8	1610	42		67		63	25		38	2,20
SPB 112 03	3	112	119	8	1610	42		72		63	25		38	2,40
SPB 118 03	3	118	125	2	1610	42		78		63	25	38		2,60
SPB 125 03	3	125	132	2	2012	50		82		63	32	31		3,20
SPB 132 03	3	132	139	2	2012	50		89		63	32	31		3,20
SPB 140 03	3	140	147	2	2012	50		97		63	32	31		3,60
SPB 150 03	3	150	157	2	2517	65		107		63	45	18		4,00
SPB 160 03	3	160	167	2	2517	65		117		63	45	18		4,50
SPB 170 03	3	170	177	2	2517	65		127		63	45	18		5,30
SPB 180 03	3	180	187	2	2517	65		137		63	45	18		5,90
SPB 190 03	3	190	197	2	2517	65		147		63	45	18		6,50
SPB 200 03	3	200	207	2	2517	65		157		63	45	18		6,70
SPB 212 03	3	212	219	6	2517	65	117	169	15	63	45	18		6,90
SPB 224 03	3	224	231	5	2517	65	117	181		63	45	18		7,50
SPB 236 03	3	236	243	5	2517	65	117	193		63	45	18		8,80
SPB 250 03	3	250	257	5	3020	75	144	207		63	51	12		10,20
SPB 265 03	3	265	272	5	3020	75	144	222		63	51	6	6	10,80
SPB 280 03	3	280	287	5	3020	75	144	237		63	51	6	6	11,30
SPB 300 03	3	300	307	5	3020	75	144	257		63	51	6	6	12,30
SPB 315 03	3	315	322	5	3020	75	144	272		63	51	6	6	13,50
SPB 335 03	3	335	342	5	3020	75	144	292		63	51	6	6	14,70
SPB 355 03	3	355	362	5	3020	75	144	312		63	51	6	6	15,90
SPB 400 03	3	400	407	4	3535	90	175	357		63	89	13	13	18,80
SPB 450 03	3	450	457	4	3535	90	175	407		63	89	26		22,50
SPB 500 03	3	500	507	4	3535	90	175	457		63	89	26		24,00
SPB 560 03	3	560	567	4	3535	90	175	517		63	89	26		30,00
SPB 630 03	3	630	637	4	3535	90	175	587		63	89	26		33,50
SPB 710 03	3	710	717	4	3535	90	175	664		63	89	13	13	35,00
SPB 800 03	3	800	807	4	3535	90	175	754		63	89	13	13	38,00
SPB 900 03	3	900	907	4	3535	90	175	854		63	89	13	13	48,00
SPB1000 03	3	1000	1007	4	4040	100	210	954		63	102	19,5	19,5	55,00
SPB1250 03	3	1250	1257	4	4040	100	210	1204		63	102	19,5	19,5	100,00

SPB - 04

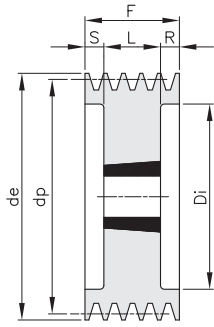

3

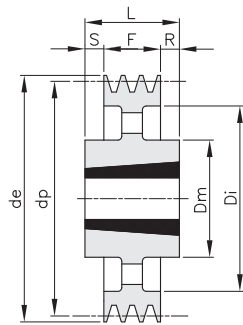

4

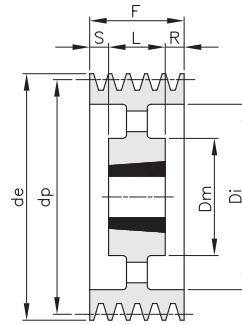

5

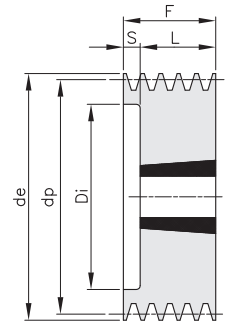

8

Материал Чугун Г20 / Material Cast Iron G20 UNI 5007

type	groves	dp	de	form	taper	bush	bore MAX	Dm	Di	E	F	L	R	S	Kg.
SPB 118 04	4	118	125	8	1610	42		78		82	25			57	4,00
SPB 125 04	4	125	132	3	2012	50		82		82	32	25		25	3,50
SPB 132 04	4	132	139	3	2012	50		89		82	32	25		25	3,70
SPB 140 04	4	140	147	3	2517	65		100		82	45	18,5		18,5	4,30
SPB 150 04	4	150	157	3	2517	65		107		82	45	18,5		18,5	4,60
SPB 160 04	4	160	167	3	2517	65		117		82	45	18,5		18,5	5,20
SPB 170 04	4	170	177	3	2517	65		127		82	45	18,5		18,5	6,10
SPB 180 04	4	180	187	3	2517	65		137		82	45	18,5		18,5	7,20
SPB 190 04	4	190	197	3	2517	65		147		82	45	18,5		18,5	7,90
SPB 200 04	4	200	207	3	3020	75		157		82	51	15,5		15,5	9,10
SPB 212 04	4	212	219	3	3020	75		169		82	51	15,5		15,5	10,00
SPB 224 04	4	224	231	3	3020	75		181		82	51	15,5		15,5	11,50
SPB 236 04	4	236	243	3	3020	75		193		82	51	15,5		15,5	12,80
SPB 250 04	4	250	257	5	3020	75	144	207		82	51	15,5		15,5	13,50
SPB 265 04	4	265	272	5	3020	75	144	222		82	51	15,5		15,5	13,80
SPB 280 04	4	280	287	5	3020	75	144	237		82	51	15,5		15,5	14,10
SPB 300 04	4	300	307	4	3535	90	175	257		82	89	7			15,80
SPB 315 04	4	315	322	4	3535	90	175	272		82	89	3,5		3,5	17,50
SPB 335 04	4	335	342	4	3535	90	175	292		82	89	3,5		3,5	18,40
SPB 355 04	4	355	362	4	3535	90	175	312		82	89	3,5		3,5	19,20
SPB 400 04	4	400	407	4	3535	90	175	357		82	89	3,5		3,5	21,00
SPB 450 04	4	450	457	4	3535	90	175	407		82	89	7			25,00
SPB 500 04	4	500	507	4	3535	90	175	457		82	89	7			27,00
SPB 560 04	4	560	567	4	3535	90	175	517		82	89	7			33,20
SPB 630 04	4	630	637	4	3535	90	175	587		82	89	7			36,00
SPB 710 04	4	710	717	4	3535	90	175	664		82	89	3,5		3,5	42,00
SPB 800 04	4	800	807	4	4040	100	210	754		82	102	10		10	53,50
SPB 900 04	4	900	907	4	4040	100	210	854		82	102	10		10	62,00
SPB1000 04	4	1000	1007	4	4040	100	210	954		82	102	16		10	68,00
SPB1250 04	4	1250	1257	4	4545	110	242	1204		82	114	16		16	114,50

SPB - 05

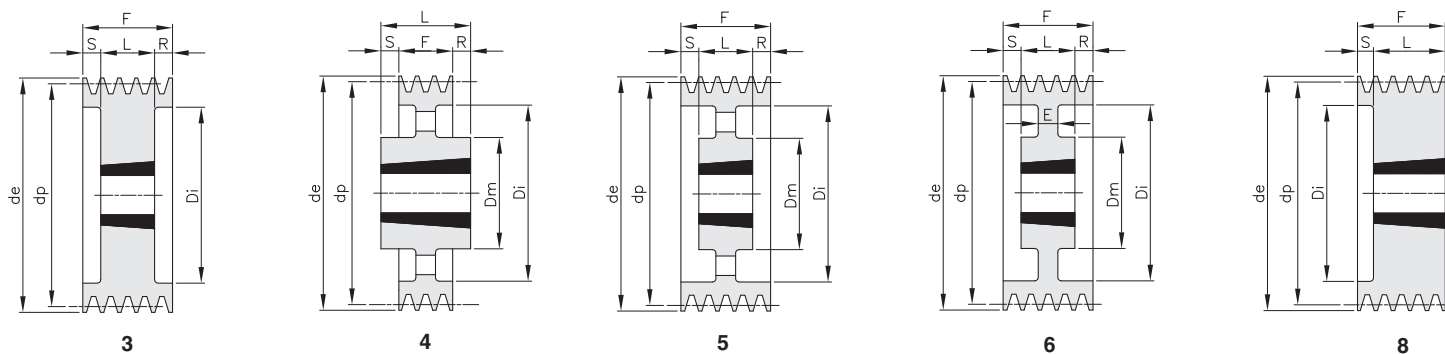

Материал Чугун Г20 / Material Cast Iron G20 UNI 5007

type	grooves	dp	de	form taper bush	bore MAX	Dm	Di	E	F	L	R	S	Kg.	
SPB 125 05	5	125	132	8	2012	50	87		101	32		69	4,20	
SPB 132 05	5	132	139	8	2517	65	94		101	45		56	4,40	
SPB 140 05	5	140	147	3	2517	65	97		101	45	28	28	4,80	
SPB 150 05	5	150	157	3	2517	65	107		101	45	28	28	5,40	
SPB 160 05	5	160	167	3	2517	65	117		101	45	28	28	6,20	
SPB 170 05	5	170	177	3	3020	75	127		101	51	25	25	7,10	
SPB 180 05	5	180	187	3	3020	75	137		101	51	25	25	7,50	
SPB 190 05	5	190	197	3	3020	75	147		101	51	25	25	8,50	
SPB 200 05	5	200	207	3	3020	75	157		101	51	25	25	9,60	
SPB 212 05	5	212	219	3	3020	75	169		101	51	25	25	11,50	
SPB 224 05	5	224	231	3	3020	75	181		101	51	25	25	13,00	
SPB 236 05	5	236	243	3	3535	90	193		101	89	6	6	16,20	
SPB 250 05	5	250	257	3	3535	90	207		101	89	6	6	17,20	
SPB 265 05	5	265	272	6	3535	90	175	222	30	101	89	6	6	17,00
SPB 280 05	5	280	287	6	3535	90	175	237	25	101	89	6	6	18,50
SPB 300 05	5	300	307	5	3535	90	175	257		101	89	6	6	19,00
SPB 315 05	5	315	322	5	3535	90	175	272		101	89	6	6	19,50
SPB 335 05	5	335	342	5	3535	90	175	292		101	89	6	6	20,40
SPB 355 05	5	355	362	4	3535	90	175	312		101	89	6	6	21,50
SPB 400 05	5	400	407	4	3535	90	175	357		101	89	6	6	24,50
SPB 450 05	5	450	457	4	3535	90	175	407		101	89	12		29,00
SPB 500 05	5	500	507	4	3535	90	175	457		101	89	12		31,50
SPB 560 05	5	560	567	4	4040	100	210	517		101	102	1		36,00
SPB 630 05	5	630	637	4	4040	100	210	587		101	102	1		48,50
SPB 710 05	5	710	717	4	4040	100	210	664		101	102	1		52,00
SPB 800 05	5	800	807	4	4040	100	210	754		101	102	1		56,20
SPB 900 05	5	900	907	4	4040	100	210	854		101	102	1		76,00
SPB1000 05	5	1000	1007	4	4545	110	242	954		101	114	6,5	6,5	85,30
SPB1250 05	5	1250	1257	4	4545	110	242	1204		101	114	6,5	6,5	150,70

SPB - 06

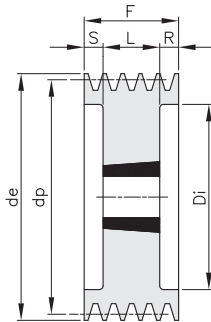

3

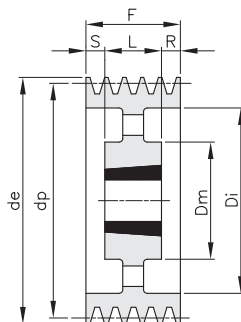

5

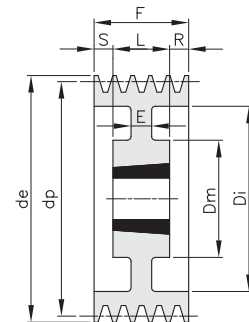

6

Материал Чугун Г20 / Material Cast Iron G20 UNI 5007

type	grooves	dp	de	form taper bush	bore MAX	Dm	Di	E	F	L	R	S	Kg.	
SPB 140 06	6	140	147	3	2517	65	100		120	45	37,5	37,5	5,80	
SPB 150 06	6	150	157	3	2517	65	107		120	45	37,5	37,5	6,80	
SPB 160 06	6	160	167	3	3020	75	118		120	51	34,5	34,5	6,90	
SPB 170 06	6	170	177	3	3020	75	127		120	51	34,5	34,5	8,10	
SPB 180 06	6	180	187	3	3020	75	137		120	51	34,5	34,5	8,20	
SPB 190 06	6	190	197	3	3020	75	147		120	51	34,5	34,5	9,40	
SPB 200 06	6	200	207	3	3020	75	157		120	51	34,5	34,5	10,50	
SPB 212 06	6	212	219	3	3535	90	169		120	89	15,5	15,5	14,50	
SPB 224 06	6	224	231	3	3535	90	181		120	89	15,5	15,5	17,50	
SPB 236 06	6	236	243	3	3535	90	193		120	89	15,5	15,5	20,00	
SPB 250 06	6	250	257	3	3535	90	207		120	89	15,5	15,5	21,50	
SPB 265 06	6	265	272	6	3535	90	175	222	30	120	89	15,5	15,5	21,00
SPB 280 06	6	280	287	6	3535	90	175	237	25	120	89	15,5	15,5	22,10
SPB 300 06	6	300	307	5	3535	90	175	257		120	89	15,5	15,5	23,50
SPB 315 06	6	315	322	5	3535	90	175	272		120	89	15,5	15,5	24,60
SPB 335 06	6	335	342	5	3535	90	175	292		120	89	15,5	15,5	26,30
SPB 355 06	6	355	362	5	3535	90	175	312		120	89	15,5	15,5	28,40
SPB 400 06	6	400	407	5	3535	90	175	357		120	89	15,5	15,5	32,90
SPB 450 06	6	450	457	5	4040	100	210	407		120	102	18		36,50
SPB 500 06	6	500	507	5	4040	100	210	457		120	102	18		40,00
SPB 560 06	6	560	567	5	4040	100	210	517		120	102	18		47,50
SPB 630 06	6	630	637	5	4040	100	210	587		120	102	18		55,00
SPB 710 06	6	710	717	5	4040	100	210	664		120	102	9	9	62,50
SPB 800 06	6	800	807	5	4545	110	242	754		120	114	3	3	71,00
SPB 900 06	6	900	907	5	4545	110	242	854		120	114	3	3	83,70
SPB1000 06	6	1000	1007	5	4545	110	242	954		120	114	3	3	100,40
SPB1250 06	6	1250	1257	5	4545	110	242	1204		120	114	3	3	136,00

SPB - 08

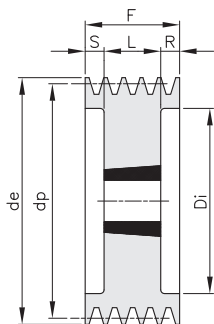

3

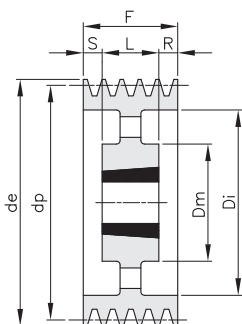

5

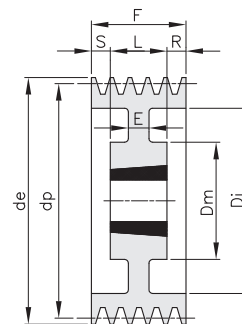

6

Материал Чугун Г20 / Material Cast Iron G20 UNI 5007

type	grooves	dp	de	form	taper	bush	bore MAX	Dm	Di	E	F	L	R	S	Kg.
SPB 140 08	8	140	147	3	2517	65			97		158	45	56,5	56,5	7,00
SPB 150 08	8	150	157	3	2517	65			107		158	45	56,5	56,5	8,00
SPB 160 08	8	160	167	3	3020	75			118		158	51	53,5	53,5	11,60
SPB 170 08	8	170	177	3	3030	75			127		158	76	41	41	10,15
SPB 180 08	8	180	187	3	3030	75			137		158	76	41	41	12,00
SPB 190 08	8	190	197	3	3030	75			147		158	76	41	41	15,60
SPB 200 08	8	200	207	3	3535	90			157		158	89	34,5	34,5	17,60
SPB 212 08	8	212	219	3	3535	90			169		158	89	34,5	34,5	20,50
SPB 224 08	8	224	231	3	3535	90			181		158	89	34,5	34,5	22,50
SPB 236 08	8	236	243	3	3535	90			193		158	89	34,5	34,5	24,00
SPB 250 08	8	250	257	3	3535	90			207		158	89	34,5	34,5	26,50
SPB 280 08	8	280	287	6	3535	90	175	237	25	158	89	34,5	34,5	34,5	28,00
SPB 300 08	8	300	307	6	3535	90	175	257	25	158	89	34,5	34,5	34,5	30,10
SPB 315 08	8	315	322	5	3535	90	175	272		158	89	34,5	34,5	34,5	31,20
SPB 335 08	8	335	342	5	3535	90	175	292		158	89	34,5	34,5	34,5	33,50
SPB 355 08	8	355	362	5	3535	90	175	312		158	89	34,5	34,5	34,5	35,70
SPB 400 08	8	400	407	5	4040	100	210	357		158	102	28	28	28	37,00
SPB 450 08	8	450	457	5	4040	100	210	407		158	102	28	28	28	42,00
SPB 500 08	8	500	507	5	4040	100	210	457		158	102	28	28	28	46,50
SPB 560 08	8	560	567	5	4545	110	242	517		158	114	22	22	22	58,00
SPB 630 08	8	630	637	5	4545	110	242	587		158	114	22	22	22	64,00
SPB 710 08	8	710	717	5	4545	110	242	664		158	114	22	22	22	72,80
SPB 800 08	8	800	807	5	4545	110	242	754		158	114	22	22	22	92,00
SPB 900 08	8	900	907	5	4545	110	242	854		158	114	22	22	22	115,00
SPB1000 08	8	1000	1007	5	5050	125	267	954		158	127	15,5	15,5	15,5	140,00
SPB1250 08	8	1250	1257	5	5050	125	267	1204		158	127	15,5	15,5	15,5	204,00

SPB - 10

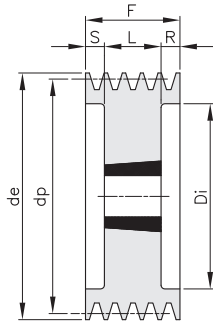

3

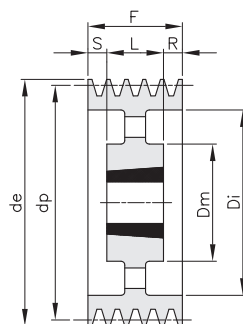

5

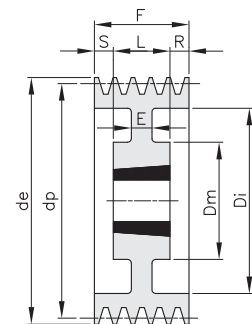

6

Материал Чугун Г20 / Material Cast Iron G20 UNI 5007

type	grooves	dp	de	form	taper bush	bore MAX	Dm	Di	E	F	L	R	S	Kg.
SPB 224 10	10	224	231	3	3535	90		181		196	89	53,5	53,5	22,50
SPB 236 10	10	236	243	3	3535	90		193		196	89	53,5	53,5	25,00
SPB 250 10	10	250	257	3	3535	90		207		196	89	53,5	53,5	29,00
SPB 280 10	10	280	287	6	3535	90	175	237	30	196	89	53,5	53,5	31,50
SPB 315 10	10	315	322	6	3535	90	175	272	30	196	89	53,5	53,5	35,00
SPB 335 10	10	335	342	5	4040	100	210	292		196	102	47	47	37,00
SPB 355 10	10	355	362	5	4040	100	210	312		196	102	47	47	38,50
SPB 400 10	10	400	407	5	4040	100	210	357		196	102	47	47	40,50
SPB 450 10	10	450	457	5	4545	110	242	407		196	114	41	41	53,50
SPB 500 10	10	500	507	5	4545	110	242	457		196	114	41	41	58,00
SPB 560 10	10	560	567	5	4545	110	242	517		196	114	41	41	64,70
SPB 630 10	10	630	637	5	4545	110	242	587		196	114	41	41	72,00
SPB 710 10	10	710	717	5	4545	110	242	664		196	114	41	41	82,40
SPB 800 10	10	800	807	5	4545	110	242	754		196	114	41	41	103,00
SPB 900 10	10	900	907	5	5050	125	267	854		196	127	34,5	34,5	131,50
SPB1000 10	10	1000	1007	5	5050	125	267	954		196	127	34,5	34,5	153,00
SPB1250 10	10	1250	1257	5	5050	125	267	1204		196	127	34,5	34,5	218,00

SPC - 03

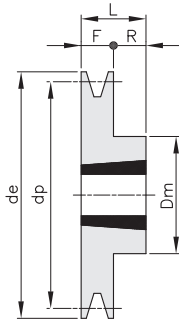

1

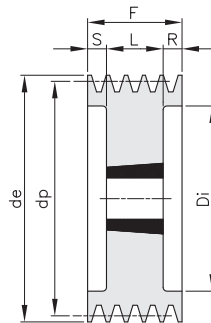

3

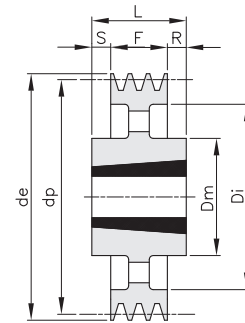

4

Материал Чугун Г20 / Material Cast Iron G20 UNI 5007

type	grooves	dp	de	form taper bush	bore MAX	Dm	Di	E	F	L	R	S	Kg.
SPC 200 03	3	200	209,6	3	2517	65	144		85	45	20	20	10,20
SPC 212 03	3	212	221,6	3	3020	75	156		85	51	17	17	11,00
SPC 224 03	3	224	233,6	3	3020	75	168		85	51	17	17	12,00
SPC 236 03	3	236	245,6	3	3020	75	180		85	51	17	17	13,00
SPC 250 03	3	250	259,6	3	3020	75	194		85	51	17	17	15,50
SPC 265 03	3	265	274,6	1	3535	90	175		85	89	4		17,20
SPC 280 03	3	280	289,6	1	3535	90	175		85	89	4		19,40
SPC 300 03	3	300	309,6	4	3535	90	175	244	85	89	2	2	22,60
SPC 315 03	3	315	324,6	4	3535	90	175	259	85	89	2	2	22,50
SPC 335 03	3	335	344,6	4	3535	90	175	279	85	89	2	2	23,50
SPC 355 03	3	355	364,6	4	3535	90	175	299	85	89	2	2	24,80
SPC 375 03	3	375	384,6	4	3535	90	175	319	85	89	2	2	25,50
SPC 400 03	3	400	409,6	4	3535	90	175	344	85	89	2	2	26,40
SPC 425 03	3	425	434,6	4	3535	90	175	369	85	89	2	2	27,00
SPC 450 03	3	450	459,6	4	3535	90	175	394	85	89	2	2	28,60
SPC 475 03	3	475	484,6	4	3535	90	175	419	85	89	2	2	30,00
SPC 500 03	3	500	509,6	4	3535	90	175	444	85	89	2	2	31,90
SPC 530 03	3	530	539,6	4	3535	90	175	474	85	89	2	2	34,50
SPC 560 03	3	560	569,6	4	3535	90	175	504	85	89	2	2	37,00
SPC 630 03	3	630	639,6	4	4040	100	210	574	85	102	8,5	8,5	44,50
SPC 800 03	3	800	809,6	4	4545	110	242	737	85	114	14,5	14,5	65,00
SPC1000 03	3	1000	1009,6	4	5050	125	267	937	85	127	21	21	93,00
SPC1250 03	3	1250	1259,6	4	5050	125	267	1187	85	127	21	21	101,00

SPC - 04

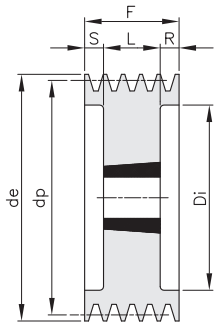

3

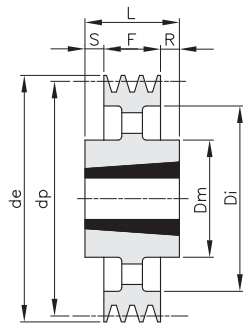

4

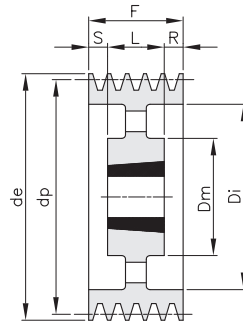

5

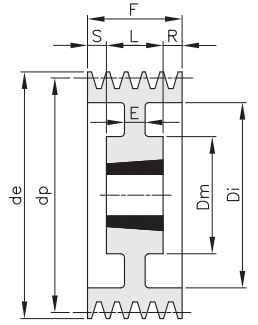

6

Материал Чугун Г20 / Material Cast Iron G20 UNI 5007

type	groves	dp	de	form	taper	bush	bore MAX	Dm	Di	E	F	L	R	S	Kg.
SPC 200 04	4	200	209,6	3	3020	75			144		111	51	30	30	12,50
SPC 212 04	4	212	221,6	3	3020	75			156		111	51	30	30	13,50
SPC 224 04	4	224	233,6	3	3535	90			168		111	89	11	11	15,00
SPC 236 04	4	236	245,6	3	3535	90			180		111	89	11	11	18,20
SPC 250 04	4	250	259,6	3	3535	90			194		111	89	11	11	21,70
SPC 265 04	4	265	274,6	3	3535	90			209		111	89	11	11	23,00
SPC 280 04	4	280	289,6	6	3535	90	175	224	18	111	89	11	11	11	24,10
SPC 300 04	4	300	309,6	6	3535	90	175	244	20	111	89	11	11	11	25,00
SPC 315 04	4	315	324,6	5	3535	90	175	259		111	89	11	11	11	26,40
SPC 335 04	4	335	344,6	5	3535	90	175	279		111	89	11	11	11	27,50
SPC 355 04	4	355	364,6	5	3535	90	175	299		111	89	11	11	11	29,30
SPC 375 04	4	375	384,6	5	3535	90	175	319		111	89	11	11	11	31,00
SPC 400 04	4	400	409,6	5	3535	90	175	344		111	89	11	11	11	32,80
SPC 425 04	4	425	434,6	5	3535	90	175	369		111	89	11	11	11	33,40
SPC 450 04	4	450	459,6	5	3535	90	175	394		111	89	11	11	11	36,80
SPC 475 04	4	475	484,6	5	3535	90	175	419		111	89	11	11	11	38,00
SPC 500 04	4	500	509,6	5	3535	90	175	444		111	89	11	11	11	40,00
SPC 530 04	4	530	539,6	5	4040	100	210	474		111	102	4,5	4,5	4,5	45,00
SPC 560 04	4	560	569,6	5	4040	100	210	504		111	102	4,5	4,5	4,5	50,00
SPC 630 04	4	630	639,6	4	4545	110	242	574		111	114	1,5	1,5	1,5	58,00
SPC 710 04	4	710	719,6	4	5050	125	267	654		111	127	8	8	8	64,00
SPC 800 04	4	800	809,6	4	5050	125	267	737		111	127	8	8	8	76,50
SPC1000 04	4	1000	1009,6	4	5050	125	267	937		111	127	8	8	8	105,00
SPC1250 04	4	1250	1259,6	4	5050	125	267	1187		111	127	8	8	8	178,00

SPC - 05

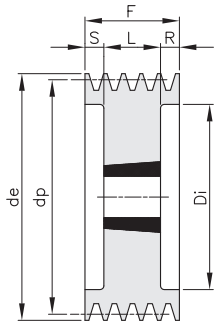

3

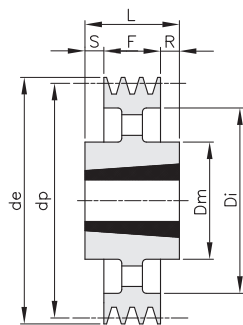

4

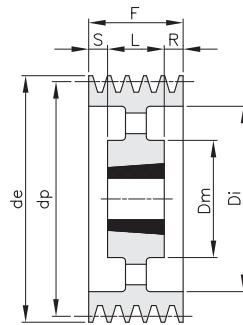

5

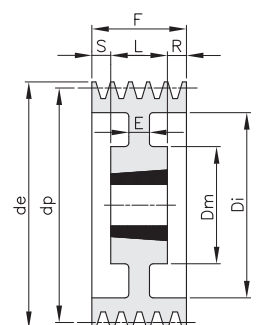

6

Материал Чугун Г20 / Material Cast Iron G20 UNI 5007

type	groves	dp	de	form	taper bush	bore MAX	Dm	Di	E	F	L	R	S	Kg.
SPC 200 05	5	200	209,6	3	3535	90		144		136	89	23,5	23,5	14,70
SPC 212 05	5	212	221,6	3	3535	90		156		136	89	23,5	23,5	15,00
SPC 224 05	5	224	233,6	3	3535	90		168		136	89	23,5	23,5	17,20
SPC 236 05	5	236	245,6	3	3535	90		180		136	89	23,5	23,5	20,20
SPC 250 05	5	250	259,6	3	3535	90		194		136	89	23,5	23,5	23,50
SPC 265 05	5	265	274,6	3	3535	90		209		136	89	23,5	23,5	25,50
SPC 280 05	5	280	289,6	3	3535	90		224		136	89	23,5	23,5	27,20
SPC 300 05	5	300	309,6	6	3535	90	175	244	20	136	89	23,5	23,5	28,50
SPC 315 05	5	315	324,6	5	3535	90	175	259		136	89	23,5	23,5	29,50
SPC 335 05	5	335	344,6	5	3535	90	175	279		136	89	23,5	23,5	31,00
SPC 355 05	5	355	364,6	5	3535	90	175	299		136	89	23,5	23,5	33,50
SPC 375 05	5	375	384,6	5	3535	90	175	319		136	89	23,5	23,5	36,00
SPC 400 05	5	400	409,6	5	3535	90	175	344		136	89	23,5	23,5	37,00
SPC 425 05	5	425	434,6	5	3535	90	175	369		136	89	23,5	23,5	43,00
SPC 450 05	5	450	459,6	5	4040	100	210	394		136	102	17	17	46,00
SPC 475 05	5	475	484,6	5	4040	100	210	419		136	102	17	17	50,30
SPC 500 05	5	500	509,6	5	4040	100	210	444		136	102	17	17	54,00
SPC 530 05	5	530	539,6	5	4545	110	240	474		136	114	11	11	57,50
SPC 560 05	5	560	569,6	5	4545	110	242	504		136	114	11	11	61,00
SPC 630 05	5	630	639,6	5	5050	125	267	574		136	127	4,5	4,5	75,00
SPC 710 05	5	710	719,6	5	5050	125	267	654		136	127	4,5	4,5	79,00
SPC 800 05	5	800	809,6	5	5050	125	267	737		136	127	4,5	4,5	96,50
SPC1000 05	5	1000	1009,6	5	5050	125	267	937		136	127	4,5	4,5	139,00
SPC1250 05	5	1250	1259,6	5	5050	125	267	1187		136	127	4,5	4,5	196,00

SPC - 06

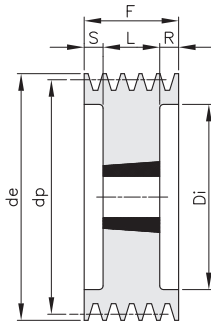

3

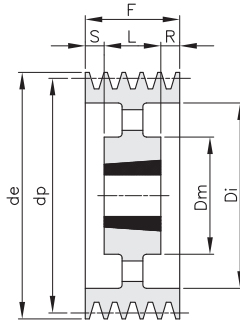

5

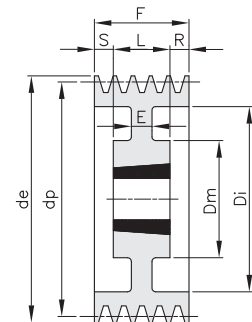

6

Материал Чугун Г20 / Material Cast Iron G20 UNI 5007

type	grooves	dp	de	form	taper bush	bore MAX	Dm	Di	E	F	L	R	S	Kg.
SPC 200 06	6	200	209,6	3	3535	90		144		162	89	36,5	36,5	17,50
SPC 212 06	6	212	221,6	3	3535	90		156		162	89	36,5	36,5	19,00
SPC 224 06	6	224	233,6	3	3535	90		168		162	89	36,5	36,5	21,00
SPC 236 06	6	236	245,6	3	3535	90		180		162	89	36,5	36,5	23,00
SPC 250 06	6	250	259,6	3	3535	90		194		162	89	36,5	36,5	26,00
SPC 265 06	6	265	274,6	3	3535	90		209		162	89	36,5	36,5	27,00
SPC 280 06	6	280	289,6	6	3535	90	175	224	20	162	89	36,5	36,5	29,00
SPC 300 06	6	300	309,6	6	3535	90	175	244	20	162	89	36,5	36,5	31,50
SPC 315 06	6	315	324,6	5	3535	90	175	259		162	89	36,5	36,5	33,20
SPC 335 06	6	335	344,6	5	3535	90	175	279		162	89	36,5	36,5	35,00
SPC 355 06	6	355	364,6	5	3535	90	175	299		162	89	36,5	36,5	37,00
SPC 375 06	6	375	384,6	5	4040	100	210	319		162	102	30	30	42,50
SPC 400 06	6	400	409,6	5	4040	100	210	344		162	102	30	30	47,50
SPC 425 06	6	425	434,6	5	4040	100	210	369		162	102	30	30	55,60
SPC 450 06	6	450	459,6	5	4545	110	242	394		162	114	24	24	62,50
SPC 475 06	6	475	484,6	5	4545	110	242	419		162	114	24	24	65,00
SPC 500 06	6	500	509,6	5	4545	110	242	444		162	114	24	24	68,20
SPC 530 06	6	530	539,6	5	5050	125	265	474		162	127	17,5	17,5	73,00
SPC 560 06	6	560	569,6	5	5050	125	267	504		162	127	17,5	17,5	86,00
SPC 630 06	6	630	639,6	5	5050	125	267	574		162	127	17,5	17,5	96,00
SPC 710 06	6	710	719,6	5	5050	125	267	654		162	127	17,5	17,5	102,00
SPC 800 06	6	800	809,6	5	5050	125	267	737		162	127	17,5	17,5	120,00
SPC1000 06	6	1000	1009,6	5	5050	125	267	937		162	127	17,5	17,5	160,00
SPC1250 06	6	1250	1259,6	5	5050	125	267	1187		162	127	17,5	17,5	232,70

SPC - 08

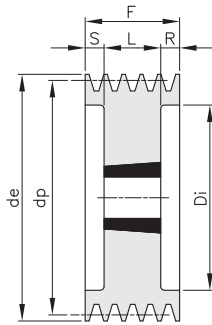

3

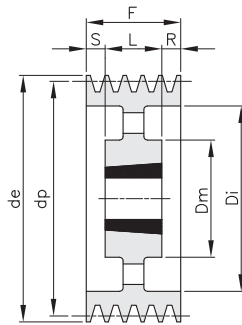

5

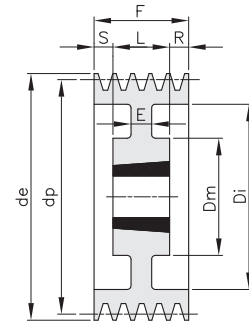

6

Материал Чугун Г20 / Material Cast Iron G20 UNI 5007

type	groves	dp	de	form	taper	bush	bore MAX	Dm	Di	E	F	L	R	S	Kg.
SPC 200 08	8	200	209,6	3	3535		90		144		213	89	62	62	17,90
SPC 212 08	8	212	221,6	3	3535		90		156		213	89	62	62	24,00
SPC 224 08	8	224	233,6	3	3535		90		168		213	89	62	62	25,00
SPC 236 08	8	236	245,6	3	3535		90		180		213	89	62	62	27,00
SPC 250 08	8	250	259,6	3	3535		90		194		213	89	62	62	30,50
SPC 265 08	8	265	274,6	3	3535		90		209		213	89	62	62	34,50
SPC 280 08	8	280	289,6	3	3535		90		224		213	89	62	62	38,50
SPC 300 08	8	300	309,6	3	4040		100		244		213	102	55,5	55,5	47,50
SPC 315 08	8	315	324,6	3	4040		100		259		213	102	55,5	55,5	51,00
SPC 335 08	8	335	344,6	6	4040		100	210	279	50	213	102	55,5	55,5	44,50
SPC 355 08	8	355	364,6	5	4040		100	210	299		213	102	55,5	55,5	57,00
SPC 375 08	8	375	384,6	5	4545		110	242	319		213	114	49,5	49,5	62,00
SPC 400 08	8	400	409,6	5	4545		110	242	344		213	114	49,5	49,5	66,50
SPC 425 08	8	425	434,6	5	4545		110	242	369		213	114	49,5	49,5	75,00
SPC 450 08	8	450	459,6	5	5050		125	267	394		213	127	43	43	80,50
SPC 475 08	8	475	484,6	5	5050		125	267	419		213	127	43	43	85,50
SPC 500 08	8	500	509,6	5	5050		125	267	444		213	127	43	43	90,20
SPC 530 08	8	530	539,6	5	5050		125	267	474		213	127	43	43	92,50
SPC 560 08	8	560	569,6	5	5050		125	267	504		213	127	43	43	109,00
SPC 630 08	8	630	639,6	5	5050		125	267	574		213	127	43	43	120,20
SPC 710 08	8	710	719,6	5	5050		125	267	654		213	127	43	43	124,70
SPC 800 08	8	800	809,6	5	5050		125	267	737		213	127	43	43	148,00
SPC1000 08	8	1000	1009,6	5	5050		125	267	937		213	127	43	43	188,20
SPC1250 08	8	1250	1259,6	5	5050		125	267	1187		213	127	43	43	260,00

SPC - 10

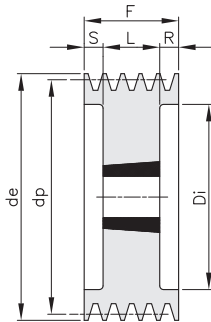

3

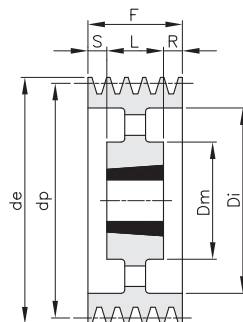

5

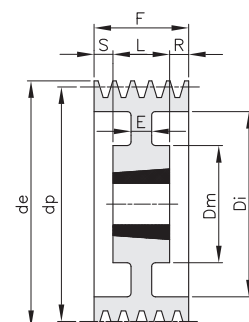

6

Материал Чугун Г20 / Material Cast Iron G20 UNI 5007

type	grooves	dp	de	form taper bush	bore MAX	Dm	Di	E	F	L	R	S	Kg.	
SPC 250 10	10	250	259,6	3	4040	100	194		264	102	81	81	39,60	
SPC 280 10	10	280	289,6	3	4040	100	224		264	102	81	81	51,40	
SPC 300 10	10	300	309,6	3	4545	110	244		264	114	75	75	57,90	
SPC 315 10	10	315	324,6	3	4545	110	259		264	114	75	75	72,00	
SPC 335 10	10	335	344,6	3	4545	110	279		264	114	75	75	76,50	
SPC 355 10	10	355	364,6	3	4545	110	299		264	114	75	75	83,40	
SPC 400 10	10	400	409,6	6	5050	125	267	344	70	264	127	68,5	68,5	80,50
SPC 450 10	10	450	459,6	5	5050	125	267	394		264	127	68,5	68,5	100,90
SPC 500 10	10	500	509,6	5	5050	125	267	444		264	127	68,5	68,5	114,00
SPC 560 10	10	560	569,6	5	5050	125	267	504		264	127	68,5	68,5	125,00
SPC 630 10	10	630	639,6	5	5050	125	267	574		264	127	68,5	68,5	126,00
SPC 710 10	10	710	719,6	5	5050	125	267	654		264	127	68,5	68,5	165,00
SPC 800 10	10	800	809,6	5	5050	125	267	737		264	127	68,5	68,5	182,00
SPC1000 10	10	1000	1009,6	5	5050	125	267	937		264	127	68,5	68,5	240,00
SPC1250 10	10	1250	1259,6	5	5050	125	267	1187		264	127	68,5	68,5	280,00